



TOOLS & SERVICE ITEMS

Accessories	440	Oil Types - Chart	221
Charging Adapters	450	Oil Injectors	452
Charging Hoses	450	RetroFit Kits (Castrol).....	442
Charging Manifolds	449	RetroFit Adapter Assortment.....	442
Chemicals and Lubricants	442	Robinair Recycling Filter	448
Clutch Plate Tools	458	Service Adapter Kits	452
Clutch Pulley Pullers	458	Service Couplers	453
Compressor Guard	454	Service Equipment	448
Dipsticks	443	Service Tool Sets	459
Flushes and Components	441	Shrader Valves and Tools	455
Gauges	450	System Guard	454
ICE³²	446	Thermometers	441
Leak Detectors	445-448	Valve Core and Tools	455, 456
Lubricant Enhancer (ICE³²)	446	Vacuum Pumps	457
Lubricants/Oils	442	Vacumm Fittings, Oil	457
Mastercool Products	447		







TOOLS and SERVICE ITEMS





Accessories

TOOLS-SERVICE ITEMS

 <p>8719 3-In-1 Can Tap Valve Use on: R12, R134a and Oil Charge Cans</p>	 <p>8727 R134a Can Tap Valve Screw on design. Gasket assures leak proof operation. Built in safety check valve. Full grip valve handle.</p>	 <p>8728 R134a Can Tap Valve Side tap design pierces the can and locks-on with one quick motion.</p>	 <p>8729 R134a Recharge Kit Screw on design with hose and quick coupler. Built in safety check valve.</p>
 <p>8730 Handi-Cut A/C Hose Cutter Makes quick clean cuts. Cuts R12, R134a, barrier and non-barrier hoses up to 1 1/2" OD. 8731 - Replacement Blade</p>	 <p>8732 A/C Ratchet Reversible 9/16", 1/2" Hex, and 1/4", 3/16" Square.</p>	 <p>8734 Coil Fin Comb Cleans and straightens evaporator and condenser coils. Six sided head for 6, 8, 10, 12, 14, and 15 fins per inch applications.</p>	 <p>8735 Safety Goggles A must for work with refrigerants and flushing agents. Quality goggles with specially designed vents</p>
 <p>8736 UV Safety Goggles These are a must for protection against ultraviolet light when using UV light for leak detection.</p>	 <p>8781 Refrigerant Hose Gasket Valve Gasket 1/4" <i>10 per pack</i></p>	 <p>8782 Refrigerant Hose Depressor Valve Depressor 1/4" <i>10 per pack</i></p>	 <p>8783 Refrigerant Hose Depressor & Gasket 1/4" Valve Depressor and Gasket <i>3 each per pack</i></p>
 <p>8990 A/C Service Tape 30 Ft. Roll</p>	 <p>8930 Orifice Tube Extractor Kit Easily removes damaged orifice tubes in Ford & GM vehicles.</p>	 <p>8890B A/C Service Manual Covers service procedures for R12 / R134a</p>	 <p>1000-DVD A/C Procedures & Classroom Training DVD - two-disc set DVD Features</p> <ul style="list-style-type: none"> • Theory & Operation • Component Function • Trouble Shooting • System Diagnosis • Service procedures

Accessories

Thermometers		
 <p>8723 Dial Thermometer 1 3/8" Face with range: -40° to 160°F</p>	 <p>8724 - 1 3/4" Face 8725 - 1 3/4" Face Dial Thermometer with range: 0° to 220°F</p>	 <p>8726 Digital Thermometer 1" Dial Size, Battery Operated, range: -58° to 320°F</p>
 <p>8746 Digital Thermometer .75" Digital Display, Battery Operated, range: -58° to 571°F</p>	 <p>8774 Infrared Thermometer w/Target Laser 7/8" Digital Display, Battery Operated, range: -4° to 932°F, 8:1 ratio</p>	 <p>8775 Dual Temp Infrared w/Contact Thermo. 7/8" Digital Display, Battery Operated, range: -76° to 1400°F, 30:1 ratio</p>

Flushing Components			
 <p>8805 - System Flush Kit Includes flush gun, hose, canister, and canister adapter. Uses shop air to propel flush solvent through each component.</p> <p>8807 - Flush Kit with quart of flush solvent</p>	 <p>8806 Replacement Flush Probe w/Tip</p> <p>8809 Replacement Rubber - Tip Only</p>	 <p>8808 Flush Capturing Unit Unit gives technician the opportunity to analyze flush debris as it is being removed. Collects flush material for reuse or disposal.</p>	 <p>8817 Flush Kit - R12/R134a systems with all oil types Contains: gun, hose, 1 gallon of flush solvent, and complete instructions. Adapts to use with all quick coupler types!</p>

A/C Flushes	
<p>Castrol's A/C Flush is an effective flushing solution that removes debris and sludge from A/C components. The solvency action of Castrol's A/C flush dissolves deposits, is compatible with R12/R134a A/C systems and contains no CFC's. With Castrol's A/C flush, flushing has never been more economical and convenient.</p> <p>Castrol's lubricant based flush is designed for use with both closed loop flushing machines and pressurized flush guns.</p> <p style="text-align: right;">Lubricant Based Flush 8811A Gallon 8812A Quart</p>	

TOOLS-SERVICE ITEMS

TOOLS and SERVICE ITEMS

TOOLS-SERVICE ITEMS

Retro Kits

R134a PROFESSIONAL RETRO KITS

Castrol's Professional Retro Kits include application specific o-rings, seals, gaskets and lubricant necessary to convert most pickups, vans, and light-medium-heavy duty trucks from R12 to R134a refrigerant. All kits also include OEM approved service ports, SAE retrofit label and retrofitting instructions.

WHILE SUPPLY LASTS
Limited Availability

- | | |
|--------------------------------------|-----------------------------------|
| 8100
CCI York / Tecumseh | 8104
Ford Products |
| 8102
Sanden / Seltec / ICE | 8105
Universal Vehicles |
| 8103
GM A6 / R4 / DA6 | 8106
GM Vehicles |



RETROFIT ASSORTMENT

8991
R134a Steel RetroFit Starter Assortment
Complete steel fitting assortment, including retrofit labels, schrader cores and port eliminator caps.



5557 5555 5556 5563

Chemicals and Lubricants

R134a/R12 POLYOL ESTER OIL

Castrol Synthetic Polyol Ester Lubricant (POE) is specifically formulated for mobile a/c systems. It's unique chemistry allows it to be used in either R12 or R134a systems. For use in factory fill or retrofit applications. Castrol's POE is approved by automotive compressor OEM's and is formulated with a proprietary additive package that requires no different handling, safety or disposal precautions than conventional mineral oil. It is compatible with R12 and R134a refrigerant, Neoprene and HNBR o-rings, and XH5, XH7 and XH9 desiccant. Ester oil is fully miscible with conventional refrigerant oils.

Ester Oil - Use when retrofitting system from **R12 to R134a** and residual amounts of mineral oil are left in the system.

- | | | | |
|-----------------|--------------------------|-------------------|--------|
| Specifications: | ISO Grade: 100 | 8201 | 8 oz. |
| | Viscosity@100°F(SUS):500 | 8202 | 12 oz. |
| | Viscosity@40°C(cSt):100 | 8203 | Quart |
| | Pour Point: -22°F | 8204 | Gallon |
| | Flash Point: 491°F | | |



Chemicals and Lubricants (continued)

R134a PAG OIL

Castrol Polyalkylene Glycol Lubricant (PAG) is specifically formulated for R134a mobile a/c systems. PAG oils are more abrasive to the skin than that of Mineral or Ester oils. Special requirements are needed when handling this product. It is compatible with R134a refrigerant only, Neoprene, HNBR, Buna N o'rings, and XH7 and XH9 desiccant. PAG oils and refrigerants are hydroscopic relative to mineral or ester oils and their exposure to air should be minimized in order to avoid excessive water absorption.

Three different viscosity grades of polyalkylene glycol lubricants formulated for R134a A/C systems are available, They meet or exceed OEM specifications.



FORD 10PA
SELTEC TM
ISO 46 PAG OIL
8207 8 oz.
8225 Quart
8226 Gallon

SANDEN
ISO 100 PAG OIL
8206 8 oz.
8227 Quart
8228 Gallon

GMC
ISO 150 PAG OIL
8208 8 oz.
8229 Quart
8230 Gallon

R12 REFRIGERANT MINERAL OIL

A premium quality wax-free, non-foaming compressor oil for all air conditioning systems using **R12** refrigerant ONLY. It is compatible with NBR, Buna N and Buna o'rings and XH5, XH7 and XH9 desiccant.

Specifications:
ISO Grade: 100
Viscosity@100°F(SUS): 525
Viscosity@40°C(cSt): 110
Pour Point: -10°F
Flash Point: 360°F



8240 Quart
8241 Gallon

UNIVERSAL A/C LUBRICANT

Castrol Universal A/C Lubricant is a high quality synthetic lubricant designed for use in all mobile air conditioning systems. It can be used in a/c systems using R12 or R-134a refrigerant.



8219 8 oz.

**SW SERIES POLYOL
Synthetic Ester Oil**



GALLON CONTAINERS

GRADE
VISCOSITY

8220	SW20	Thermoking / Carrier Applications
8221	SW22	Recovery / Recycling Equipment Applications
8222	SW32	R12/R22/R502/R114/MP39/MP66/HP62 Applications
8223	SW68	R12/R22/R502/R114/MP39/MP66 Applications

SANDEN R134a PAG SP15 OIL



8248 8.45 oz.



8166
Dipstick - Sanden oil level checker

Used when servicing Sanden Compressors in systems that are charged with 134a. For use with SD 508, 510, 709, 5H14, 7H15 Compressors. **(SP15 replaces SP20)**

TOOLS-SERVICE ITEMS

TOOLS and SERVICE ITEMS

TOOLS-SERVICE ITEMS

Chemicals and Lubricants (continued)

VALEO R134a PAG OIL ISO VG 46



8250A 354cc

Used when servicing Zexel Compressors in systems that are charged with R134a. For use with DKS 15, 16, 17, 26 compressors.

VACUUM PUMP OIL



8255 Gallon

8256 Quart

8257 12 oz.

Promotes internal sealing for good vacuum and absorbs unwanted vapor from evacuated units. Regular oil changes promote longer vacuum pump life.

POLYOL ESTER OIL CHARGE



8210 4 oz.

8212 12 oz.

A quick and easy way to add premium lubricant to an A/C system without having to discharge the refrigerant.

PAG OIL CHARGE



8209 4 oz. PAG 46 (high viscosity)

8215 4 oz. PAG 150 (low viscosity)

A quick and easy way to add premium lubricant to an A/C system without having to discharge the refrigerant.

Lube and Seal



8217 9 oz. Aerosol

Premium mineral lubricant specially formulated for use with all A/C systems. Lubricates and seals parts such as o-rings, fittings, compressor shaft seals, and gaskets to assure a safe reliable seal.

R134a Stop Leak



8218 4 oz.

Castrol's stop leak detects and helps to seal most common leaks in R134a A/C systems.

Big Blue™ Leak Finder



BIG BLUE LEAK FINDER

Works like magic,
A must for every shop!

8473 16 oz. Spray Bottle

8474 1 Gallon Refill

Micro Leak Detector Spray Coating

The only bubble/foam indicator capable of detecting freon (gas) leakage down to 0.65 oz. per year.

Leak Detectors, Dyes and Accessories

TRACERLINE- Leak Detection



8449

EZ-Ject™ Leak Detection Kit

Kit includes:

- Inspection lamp
- Dye injection gun w/R134a hose/coupler w/R12 adapter/fitting
- Dye cartridge universal for all a/c systems
- Dye for all oil-based fluids(1 oz. bottle)
- Leak dye coolant/auto body (1 oz. bottle)
- Plastic case
- Enhancing glasses
- Underhood labels



8448

EZ-Shot™ Leak Detection Kit

Kit includes:

- Inspection lamp
- Dye injection gun, hoses, couplers for R-12/R134a systems
- Dye cartridge (8oz.) universal for all a/c systems
- Dye cleaner spray bottle (8oz.)
- Plastic case
- Enhancing glasses
- Underhood labels

8458

OPTIMAX Jr™

Mini flashlight reveals leaks, Compatible with all leak dyes, Ultra compact, lightweight, LED bulb, batteries included.



8443

EZ-Shot™ Injector

Used to inject dye cartridges.

8475 4 oz.

8476 8 oz.

A/C Dye Cartridges

Prefilled and disposable

TOOLS-SERVICE ITEMS

Stick Capsules

Tracer stick is injected into the A/C system through the low pressure valve. The A/C system is then operated to thoroughly circulate the dye in the system. When the refrigerant escapes from the system, it will leave a residual amount of dye at the point of leakage. The ultraviolet light will then locate the point of leakage revealed by a bright fluorescent glow.



Low Side Small Capsules For 1-2.9 lbs. Refrigerant Systems

8460	Ester R134a	.03 oz. Capsule	Qty 6 ea.
8460EA	Ester R134a	.03 oz. Capsule	Qty 1 ea.
8461	PAG R134a	.03 oz. Capsule	Qty 6 ea.
8461EA	PAG R134a	.03 oz. Capsule	Qty 1 ea.

Low Side Large Capsules For 3-4.9 lbs. Refrigerant Systems

8463	Ester R134a	.5 oz. Capsule	Qty 6 ea.
8463EA	Ester R134a	.5 oz. Capsule	Qty 1 ea.
8464	PAG R134a	.5 oz. Capsule	Qty 6 ea.

Tracer Stick Capsules

Disposable capsules come pre-filled with a pre-measured dose of dye suited to the type and amount of refrigerant/lubricant in a system (use multiple capsules for larger systems).

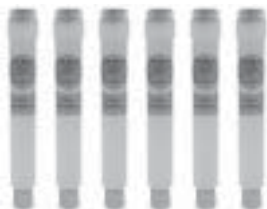

EZ-Ject Multi-Dose Dye Cartridges

8466	Ester R134a	.5 oz. Cartridge	Qty 6 ea.
8467	PAG R134a	.5 oz. Cartridge	Qty 6 ea.
8468	Mineral Oils	.5 oz. Cartridge	Qty 6 ea.

8477 8oz.

All-In-One Dye

For gasoline, diesel engine oils, fuel; a/trans., power steering, hydraulic and lubrication fluids.



TOOLS and SERVICE ITEMS

TOOLS-SERVICE ITEMS

A/C Lubricant Enhancer



Typical truck installation (one evaporator) use 1.5 oz. with sleeper unit use 2 oz. (recommended)

- Cold Air Faster
- Reduces Interior Humidity
- Extends Compressor Life
- Increases Heat Transfer Efficiencies
- Works Year-Round



8301
3.0 oz. Aerosol Can
(2 oz. of ICE³² Lubricant Enhancer and 1 oz. of R134a)



8302
8 oz. bottle, non-aerosol
(ICE³² Lubricant Enhancer)



8303
1.5 oz. bottle, non-aerosol
(ICE³² Lubricant Enhancer)



8304
Aerosol Can Installation Kit
Kit includes: Can Tap, Fittings, Gauge, Injector Hose, Instructions



8305
Manual Injector Kit
Fast, Easy and Simple!
Connect injector to the low side service port of the A/C system.
Uses #8302 or #8303 bottles.



8306
Start Up Kit
Kit includes: All Season consumer brochures sm. (25/pk), Counter Display, Pocket Brochure, Poster, Window Decal



8310
Toolbox Demo Kit

- Kit Includes:
- 3.0 oz ICE32 (8301) 3 Cans
 - 1.5 oz ICE32 (8303) 6 Bottles
 - Aerosol Injector Kit (8304) 1
 - Manual Injector (8305) 1
 - Clear Safety Goggles 1
 - Clipboard 1
 - Consumer Brochures 2 Packs
 - ICE32 Aerosol Video 1
 - ICE32 Installation Forms 2 Pkgs
 - Plastic Tool Box 1
 - Uei Digital Thermometer 1
 - Under Hood Stickers 2 Sheets
 - Window Decals 2

Leak Detectors, Dyes and Accessories

Mastercool™ UV Leak Locator Kits



8445A - UV LEAK LOCATOR KIT

- FLEXnGLOW™ Compact Kit Design
- Brilliant 12V/50 Watt UV Light
- Compact Professional Dye Injector
- 10 Applications (R12/R134a universal concentrated dye)
- UV Enhancing Safety Glasses
- Dye Cleaner
- R12 Adapter
- 10 Service Info. Labels

Uses #8470 dye cartridges.



8446 - UV LEAK LOCATOR KIT

- FLEXnGLOW™ Light
- R12 Adapter
- 10 Applications (universal concentrated dye)
- 10 Service Info. Labels
- Includes UV Enhancing Safety Glasses
- Mini Dye Injector with Hose/Low Side, R134a Coupler

Uses #8470 dye cartridges.

Mastercool™ UV Compact Light

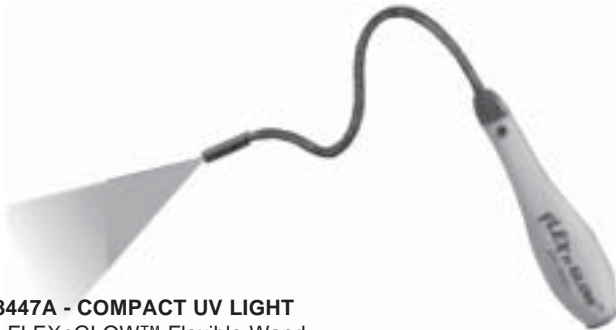

8447A - COMPACT UV LIGHT

- FLEXnGLOW™ Flexible Wand
- Quad UV Light - 4 bulbs
- Bright LED Technology
- Rugged Ergonomic Grip
- Includes UV Enhancing Safety Glasses

Mastercool™ Replacement Dyes



8470 10 application dye ONLY FITS: 8445A & 8446 injectors.
12 c.c. bottle R12/R134a Dye Cartridge

8471 25 application dye ONLY FITS: 8445 & 8457 injectors.
25 c.c. bottle R12/R134a Dye Cartridge

Mastercool™ Cartridge Type Dye Injector



8457

Dye Injector (Cartridge Type)

Adding dye is fast and easy, simply connect the injector to the low side of the A/C System and twist the handle to the next application line. Replaceable cartridges provide 25 applications of dye that is compatible with R12/22/502 and R134a Systems. The injector hose comes complete with an R134a coupler and a drip free control valve for 1/4 flare systems.

Uses #8471 dye cartridges.

TOOLS & SERVICE ITEMS

Leak Detectors, Dyes and Accessories

TOOLS-SERVICE ITEMS

Mastercool™ Electronic Leak Detectors



8770A Electronic Leak Detector
 An Accurate And Reliable Solution To Electronic Leak Detection

- 3 levels of sensitivity (5 levels of detection)
- Visual leak level indicator
- Detects leaks as small as 1/4 ounce (7gr) per year
- Custom molded carrying case

8773 Replacement Sensor Tip

THE INSPECTOR

This new design allows the user to perform electronic and UV leak detection all with one tool. The ultra bright UV light is built into the end of the probe allowing easy access into tight areas. Incorporating both electronic and UV technology into one unit insures that even the toughest leaks can be found.



8771 2-In-1 Electronic UV Leak Detector
 The INSPECTOR offers:

- 6 levels of sensitivity (15 levels of detection)
- Ultra Bright UV/Blue LEDLight
- UV Safety Glasses
- Tri-Colored visual leak level indicator
- Mute function
- Detects leaks as small as 1/10 ounce (3gr) per year
- Custom molded carrying case

8772 Replacement LED Bulb
8773 Replacement Sensor Tip

Service Equipment

Robinair Filters

8418 Portable Recycler - Includes 30 lb. DOT Tank
 Recovers and removes moisture, oil and debris from refrigerant. New Recovery System offers a State of the Art 1/2 hp Oil-less Compressor with a built-in High Volume Cooling Fan for fast recovery. Color-coded Sight Gauge identifies when Filter Dryer replacement is needed. Complete A/C Recovery System Unit with built in Oil Separator and Filter Dryer, 30 lb. DOT Tank and Cable, 72" Yellow and Blue Hoses, R134a Low Side Coupler and Oil Purge Bottle

8705 R134a 30 lb. Recovery Refrigerant Tank



8707 Quick Change Recycling Filter
 Flare type for older Robinair Models: 17700A, 34430, 34450, 34700 series



8708 Spin-On Recycling Filter Drier
 for Robinair Model: 34134K-2K., 17700-2K, 34234, 34300-2K, 34700 thru 34900 series

Service Equipment (continued)

8414 (R134a) Portable Electronic Charging Stations

A lightweight, durable, steel frame cart that contains all the necessary tools to quickly and conveniently charge the A/C system. No need for different sized charging cylinders with Mastercool's rugged die cast electronic scale. Simply place the refrigerant cylinder on the scale and charge.



MANIFOLD VACUUM

- 2-Way Aluminum Block
- 5 CFM 110v / 60Hz

8750 (R134a) Digital Manifold Set

A plastic molded case includes a manifold with a set of 3 -72" hoses and a set of manual couplers.



SPECIFICATIONS

- Pressure Display: PSI, IN-Hg, BAR, MPa and kg/cm²
(Low Side Range: 0 - 350 PSI)
(High Side Range: 0 - 500 PSI)
- Operating Temperature: 16 - 42°C (60 - 108°)
- Battery Life: 50 hours
- Idle Mode: 400 hours
- Auto Shut-off: 15 minutes

Charging Manifolds

8753 (R134a) Deluxe Aluminum 4-Way Manifold

Manifold gauge set with three 72" color-coded hoses with quick coupling valves. Four-way manifold gauges give you more control over air conditioning service. Four ball valves control refrigerant flow, vacuum and access to the system high and low sides with only a quarter turn. Four-way manifolds attach to service tools and the A/C system once. After that, control everything with a simple quarter turn of the valves.

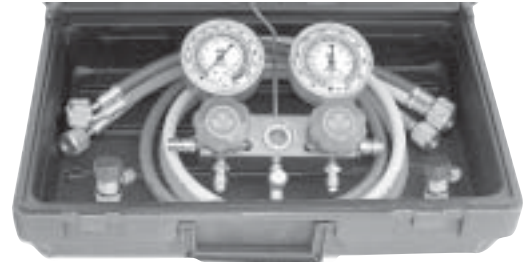

8754 (R134a) Deluxe Brass Side Wheel Manifold

Manifold gauge has three 72" R134a color coded hoses with quick coupling valves. Silicone dampened anti-flutter gauges, extruded aluminum manifold body with easy access hand valves attached to free floating piston valves for smooth and trouble free operation.

8755 (R12) Deluxe Brass Side Wheel Manifold

Manifold gauge set with three 72" color-coded hoses with quick coupling valves. Unit has brass forged body for extreme durability with angled side hand valves for ease of operation. Double o-ring seals for smooth action valves and anti-flutter gauges for smooth pressure readings.



8756 (R12/R134a) Dual Brass Manifold Set

Manifold gauge has three 72" nylon hoses, standard couplers, tank adapter, and 2 1/2" silicone anti-flutter gauges.



8869 R134a Conversion Kit

Converts R12 manifold set to R134a.



8416A Accu-Charge Electronic Refrigerant Scale

Features include 15 minute auto-off function, memory function saves last weight when unit shuts off, 176 pound capacity, 60 hour performance on one 9V alkaline battery, compact 9"x9" platform, carrying case, extra large LCD display and reliable membrane keypad switches.



TOOLS and SERVICE ITEMS

TOOLS-SERVICE ITEMS

Replacement Compound Gauges

2 1/2" Diameter



8760 R12
High Side Pressure Gauge (Red)
8761 R12
Low Side Pressure Gauge (Blue)

2 1/2" Diameter



8764 R134a
High Side Pressure Gauge (Red)
8765 R134a
Low Side Pressure Gauge (Blue)

3 1/8" Diameter



8766 R134a
High Side Pressure Gauge (Red)
8767 R134a
Low Side Pressure Gauge (Blue)

Replacement Charging Hoses with Quick Seal Fittings



R134a

Length	96"	144"
Blue	8790	8798
Red	8791	8799
Yellow	8792	8801

R12

Length	96"
Blue	8793
Red	8794
Yellow	8795



Charging Hose Sets



8797
96" Charging Hose Set - R134a
14mm x 1/2" ACME



8796
96" Charging Hose Set - R12
1/4" Standard hoses with Quick Seal fittings

Charging Adapters



8867
Manual Control Valve
1/4" FFL x 1/4" MFL
8868
Manual Control Valve
1/4" FFL x 13mm













8880 - 14MM Female x 16MM Quick Disconnect (blue - low side)
8881 - 14MM Female x 13MM Quick Disconnect (red - high side)
90° Manual Shut Off Valve - R134a
Includes high/low side quick connector, 7" barrier-type hose and termination shutoff valve to prevent the release of refrigerant trapped in the charging hose.



8887
Manual Shut-Off Ball Valve
1/4" x 1/4" Swivel Ball less hose

(continued)

Charging Adapters (continued)

 <p>8891 GM High Side Service Port 1/4" x 3/16" Female</p>	 <p>8892 90° GM High Side Service Port 1/4" x 3/16" Female</p> <p>8893 90° GM High Side Service Port 1/4" x 1/4" Female</p>	 <p>8896 Charging Adapter 6" Flexible 1/4" x 1/4"</p>	 <p>8897 Charging Adapter Ford 1/8" High Side Adapter</p>
 <p>8898 Charging Adapter GM 6" Flexible 1/4" x 3/16"</p>	 <p>8899 Access Service Valve 1/2" ACME-M x 1/8" MPT</p>	 <p>8900 Schrader Adapter Fitting For installation in drier pressure ports. 3/8" x 7/16"</p>	
 <p>8904 1/4" x 1/4" 8905 1/4" x 3/16" Straight Manual Shut Off Valve 1/4" turn ball valve controls the flow of refrigerant. Anti-Blowback fitting automatically shuts off high side charging hose when disconnected from system; no refrigerant loss or finger burns.</p>		 <p>8906 Fits All Adapter Kit Top quality adapters used to hook up to high side of vehicle AC systems for service. Five different adapters, three flexible and two 90°, are included to give full coverage.</p>	
 <p>8907 1/4" x 1/4" 8908 1/4" x 3/16" 90° Manual Shut Off Valve - R12 Manual control valve controls the flow of refrigerant, meeting EPA requirements to contain R12. Attaches to charging hose end.</p>		 <p>Quick Seal Fitting Adapter Anti-blow back fitting for charging hoses.</p> <p>8910 1/4" MFL x 1/4" FFL 8911 1/4" MFL x 3/16" FFL 8909 1/2" ACME x 1/2" ACME 8784 Replacement Seal</p>	

TOOLS and SERVICE ITEMS

TOOLS-SERVICE ITEMS

Service Adapter Kits and A/C Service Repair Kit



8883
Deluxe A/C Service Repair Kit
 Replacement gaskets, depressors, and o-rings for charging hoses and adapters.

- | Kit Includes: | Part# |
|--|-------|
| • 1/4" Gasket (10 pcs) | 8781 |
| • 1/4" Depressor (10 pcs) | 8782 |
| • O-Ring for 8913 (10 pcs) | 8870 |
| • O-Ring for 8912 (10 pcs) | 8871 |
| • Gasket for R134a hose (10 pcs) | 8875 |
| • O-Ring for R134a hose (10 pcs) | 8876 |
| • Gasket for 8909 (10 pcs) | 8877 |
| • Gasket for R12 Shut-off valve (10 pcs) | 8882 |



8884
Universal A/C Adapter Set
 Kit Includes:
 • 1/4" x 1/4" shut-off
 • 1/4" x 3/16" shut-off
 • GM 1991 & later service adapter
 • 1/4" x 3/16" GM flex
 • 1/4" x 1/8" Ford flex
 • Ford quick disconnect
 • GM & Ford quick disconnect
 • GM Large Bore quick disconnect



8885
Safety A/C Adapter Set
 Kit Includes:
 • 1/4" x 1/4" shut-off
 • 1/4" x 3/16" shut-off
 • GM 1991 & later service adapter
 • 1/4" x 3/16" GM flex
 • 1/4" x 1/8" Ford flex
 • Misc. gaskets, valve cores, depressors



8886
Popular A/C Adapter Set
 Kit Includes:
 • 1/4" x 1/4" shut-off
 • 1/4" x 3/16" shut-off
 • GM 1991 & later service adapter
 • 1/4" x 1/8" 90° shut-off (Ford high side)
 • 1/4" x 3/16" shut-off
 • Ford quick disconnect
 • GM Large Bore quick disconnect

Oil Injectors



8737 Oil Injector - R12
8738 Oil Injector - R134a
 Can be used with charging stations or manifold gauge sets to measure and dispense up to 2 ounces of oil.





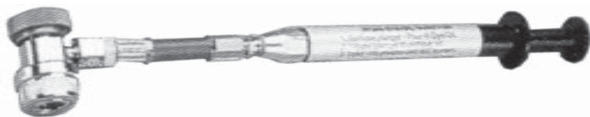





8739 Oil Injector - R12
8740 Oil Injector - R134a
 Installs on the low side of the manifold to pull refrigeration oil into the system while under vacuum.







8741 Syringe Oil Injector - R134a
8742 Syringe Oil Injector - R12
 Use to add refrigeration oil to fully charged A/C systems-the fittings connect to the low side access port. Fill the barrel with the amount of oil needed (levels are clearly marked), connect to the port and press the plunger. A check valve prevents any backflow of refrigerant. Also can be used to inject fluorescent dye.



8744 Oil Injector - R12
8743 Oil Injector - R134a
 Add oil by allowing vacuum to pull it in after evacuation process or use refrigerant to push it in using the recharge process, measures and dispenses up to 2 ounces of oil.

R134a Service Couplers		
 <p>8720 Vacuum Pump Fitting - Retro-Adapter to convert R12 pumps to R134a</p>	 <p>8722 "T" Style Retro-Adapter to convert R12 Pumps to R134a</p>	 <p>8745 ACME T-Fitting w/o Schrader</p>
 <p>8721 Retro-Adapter 1/4" Female x 1/2" ACME to convert R12 Pumps to R134a</p>	 <p>8869 R134a Conversion Kit to converts R12 manifold set to R134a.</p>	<p>Coupler Repair Components</p>  <p>8870 5 guides & 5 o-rings 8871 5 guides & 5 o-rings 8872 10 o-rings 8873 10 o-rings</p>
 <p>8851 Low Side Coupler - blue 8850 High Side Coupler - red Unique swivel design enables user to access all service ports even in the tightest applications</p>	 <p>8894 Straight Adapter, R134a (low side) 13 mm x 1/2" ACME Female</p>	 <p>8895 Adapter Coupler, R134a 1/4" Flare (7/16"-20) x 1/2" ACME</p>

TOOLS-SERVICE ITEMS

Springlock Tools and Couplers			
 <p>8160 Spring Lock Disconnect Tool Set includes four sizes: 3/8", 1/2", 5/8", and 3/4".</p>	 <p>Individual Disconnect Tools 8161 #6 8162 #8 8163 #10 8164 #12</p>	 <p>Springlock Coupling Repair Kits Nylon Construction. 8980 #6 (3/8") 8981 #8 (1/2") 8982 #10 (5/8") 8983 #12 (3/4")</p>	 <p>8985 R12/R134a Ford Spring Lock O-Ring Kit Garter springs & O-Rings for all size couplers used on 1981 to present Fords.</p>

TOOLS and SERVICE ITEMS

System Guard

Protect your work with tamper resistant SYSTEM GUARD

- Insures the service dealer that the customer will come back to him for service
- Assure the service dealer that his shop was the last one to work on the system
- Tamper evident seal protects your work
- Reduce unnecessary warranty work
- Prevent risk of cross-contamination

This Air Conditioning System has been protected with System Guard™ Tamper Evident Sleeves. Removal of Sleeves May Void Warranty.		System Guard™
Refrigerant Type: R-12 <input type="checkbox"/> R-134A <input type="checkbox"/>		
High Side Serial Number _____		
Low Side Serial Number _____		
Repair Facility _____		
City _____	State _____	Zip _____
Date of Service _____ / _____ / _____		



- 8776 10 Vehicle Kit (Aeroquip Style)
- 8777 20 Vehicle Kit
- 8778 50 Vehicle Kit
- 8779 125 Vehicle Kit



Slide over charge port cap



Heat with heat gun



System is protected

Compressor Guard

Prevent compressor loss with A/C COMPRESSOR GUARD

- A suction side screen safely removes debris before it harms a compressor
- Quick and easy installation
- Maintains OE configuration
- No hose cutting means no additional leak points
- Screen available in a variety of sizes



8830 Complete Kit
Includes 3 extractors, 2 mandrel installers, sizing gauge, 4 ea. of three different screen sizes.

Replacement Screens

- 8835 5 Pack "A" Screens .510 O.D.
- 8836 5 Pack "B" Screens .552 O.D.
- 8837 5 Pack "C" Screens .595 O.D.



Special insertion tool seats the screen securely in the suction side



Extractor tool easily removes screen from the suction side



The suction screen prevents debris from entering the compressor

Schrader Valves & Tools

 <p>8914 GM High Flow Large Bore Valve Core 10 per box</p>	 <p>8915 R12/R134a Replacement Valve Core Standard 1/4" Service port 10 per box</p>	 <p>8916 R134a Hi-Flow JRA M6 Valve Core 10 per box</p>	 <p>8917 R12 Valve Core Removal Tool</p> <p>8918 R134a Valve Core Removal Tool</p>												
 <p>8919 R12/R134a Universal Schrader Core Remover</p>	 <p>8921 R12 Schrader Valve Retreading Tool Cleans and Deburs O.E. Schrader Ports</p>	 <p>8922 R134a Service Port Reamer Tool Eliminates burrs which nick and cut coupler o'rings causing them to leak.</p>	 <p>8924 R12 Schrader Tool with storage for extra cores, includes 6 cores.</p>												
 <p>8925 Eaton M8 13mm SSV High Flow High Side 10 per box</p>	 <p>8926 Eaton M10 16mm SSV High Flow Low Side 10 per box</p>	 <p>8927 R134a Heavy Duty Core Removal Tool</p>	 <p>8936 Low Side - R134a 8937 High Side - R134a Octagon Service Port Socket Specially designed thin wall sockets for eight sided retrofit adapter.</p>												
<table border="1"> <tr> <td data-bbox="212 1507 305 1814"> <p>8915 (20 per)</p>  <p>Universal Standard Flow Valve Core R-12 & R-134a</p> </td> <td data-bbox="305 1507 397 1814"> <p>8916 (10 per)</p>  <p>High Flow JRA Valve Core - R-134a</p> </td> <td data-bbox="397 1507 490 1814"> <p>8914 (10 per)</p>  <p>GM High Flow Large Bore Valve Core - R-12 & R-134a</p> </td> <td data-bbox="490 1507 583 1814"> <p>(10 per)</p>  <p>STV / POA / VIR Oil Bleed Low Pressure Valve Core R-12 Only</p> </td> <td data-bbox="583 1507 675 1814"> <p>8925 (5 per)</p>  <p>Eaton 13MM SSV High Flow Valve Core R-134a</p> </td> <td data-bbox="675 1507 768 1814"> <p>8926 (5 per)</p>  <p>Eaton 16MM SSV High Flow Valve Core R-134a</p> </td> </tr> </table> <table border="1"> <tr> <td data-bbox="922 1507 1192 1671"> <p>8916 (3 ea.)</p>  </td> <td data-bbox="1192 1507 1461 1671"> <p>5552 (2 ea.)</p>  </td> </tr> <tr> <td data-bbox="922 1671 1192 1835"> <p>8915 (10 ea.)</p>  </td> <td data-bbox="1192 1671 1461 1835"> <p>8914 (3 ea.)</p>  <p>8919 (1 ea.)</p>  </td> </tr> </table> <p>8938 R12/R134a - Schrader Valve Core Kit</p> <p>8978 R134a - Valve Core Repair Assortment Kit</p>						<p>8915 (20 per)</p>  <p>Universal Standard Flow Valve Core R-12 & R-134a</p>	<p>8916 (10 per)</p>  <p>High Flow JRA Valve Core - R-134a</p>	<p>8914 (10 per)</p>  <p>GM High Flow Large Bore Valve Core - R-12 & R-134a</p>	<p>(10 per)</p>  <p>STV / POA / VIR Oil Bleed Low Pressure Valve Core R-12 Only</p>	<p>8925 (5 per)</p>  <p>Eaton 13MM SSV High Flow Valve Core R-134a</p>	<p>8926 (5 per)</p>  <p>Eaton 16MM SSV High Flow Valve Core R-134a</p>	<p>8916 (3 ea.)</p> 	<p>5552 (2 ea.)</p> 	<p>8915 (10 ea.)</p> 	<p>8914 (3 ea.)</p>  <p>8919 (1 ea.)</p> 
<p>8915 (20 per)</p>  <p>Universal Standard Flow Valve Core R-12 & R-134a</p>	<p>8916 (10 per)</p>  <p>High Flow JRA Valve Core - R-134a</p>	<p>8914 (10 per)</p>  <p>GM High Flow Large Bore Valve Core - R-12 & R-134a</p>	<p>(10 per)</p>  <p>STV / POA / VIR Oil Bleed Low Pressure Valve Core R-12 Only</p>	<p>8925 (5 per)</p>  <p>Eaton 13MM SSV High Flow Valve Core R-134a</p>	<p>8926 (5 per)</p>  <p>Eaton 16MM SSV High Flow Valve Core R-134a</p>										
<p>8916 (3 ea.)</p> 	<p>5552 (2 ea.)</p> 														
<p>8915 (10 ea.)</p> 	<p>8914 (3 ea.)</p>  <p>8919 (1 ea.)</p> 														

TOOLS-SERVICE ITEMS

TOOLS and SERVICE ITEMS

TOOLS-SERVICE ITEMS

Valve Core Service Tools

These durable and versatile tools perform three time saving service tasks:

1. Removal and replacement of service valve cores without losing system charge.
2. Temporary removal of valve cores for quicker, more complete recovery, evacuation, and recharge.
3. Calculation of superheat with excellent accuracy by reading refrigerant temperature & pressure from the same location in the system.



8931
Valve Core Remover/Installer

Sturdy ball valve design controls refrigerant flow with 1/4 turn of the valve. Lever position also gives visual indication of whether valve is opened or closed.



8932
Valve Core Remover/Installer with Access Port

Temporary removal of service valve core eliminates the restriction it creates and provides full flow of refrigerant and vacuum during recovery, evacuation, and recharge saving valuable service time.



8933
Superheat Determination Set

Special Valve core remover/installer adapter allows replacement of damaged or faulty service valve cores without discharging the system. Valve replacement no longer requires time consuming refrigerant recovery. Calculation of superheat with excellent accuracy by reading refrigerant temperature and pressure from the same location in the system.



8934 R134a
Valve Core Remover/Installer

Includes special R134a service port adapters.



8935
GM Large Bore Valve Core Remover/Installer

Includes 1/4" x 3/16" adapter and 1/4" x 1/8" adapter.

Valve Core Service Tool Kits



8950 R12/R134a
Universal Master Kit

- Valve Assembly
- R134a high side 16mm connector
- R134a low side 13mm connector
- 1/4" FL swivel connector
- Standard valve core remover/installer assembly
- GM large bore valve core remover/installer assembly
- JRA R134a valve core remover/installer
- Eaton R134a low side valve core remover/installer
- Eaton R134a high side valve core remover/installer
- Adapter 1/4"-M x 3/16"-F high side GM/Ford
- Adapter 1/4"-M x 1/8"-F high side Ford



8951 R134a
Standard & JRA (M6) Valve Core Kit

- Valve Assembly
- Standard R134a valve core remover/installer assembly
- R134a high side 16mm connector
- R134a low side 13mm connector



8952 R134a
Eaton (M8 & M10) Valve Core Kit

- Valve Assembly
- Eaton R134a low side valve core remover/installer
- Eaton R134a high side valve core remover/installer
- R134a high side 16mm connector
- R134a low side 13mm connector

Vacuum Pumps

PART#	No. of Stages	Free Air Displacement	Ultimate Vacuum	Pump Speed	Motor	Elec. Specs.	Weight
8709	2	1.5 cfm	50 microns	1/6 hp	3450 rpm	110V/60 hz	12 lbs.
8710	1	2 cfm	70 microns	1/3 hp	1725 rpm	110V/60 hz	28 lbs.
8711		1.3 cfm	Air Operated - Requires 4.5cfm/90psi shop air				
8712	2	5 cfm	25 microns	1/3 hp	1725 rpm	110V/60 hz	32 lbs.
8713	2	7.5 cfm	25 microns	1/2 hp	1725 rpm	110V/60 hz	34 lbs.

8709
1.5 CFM Two Stage Vacuum Pump
Multi-refrigerant compatible.
Works with R12 & R134a.



Air Disp. 1.5 CFM
Drive Direct
Motor Size 1/6HP
Voltage 110-115V
Micron Rating ... 50 Microns
Oil Capacity 8 oz.
Intake Fitting 1/2" ACME 1/4" Flare

8710
2 CFM Single Stage Vacuum Pump
Multi-refrigerant compatible.
Works with R12 & R134a.



Air Disp. 2 CFM
Drive Direct
Motor Size 1/3HP
Voltage 110-115V
Micron Rating ... 70 Microns
Oil Capacity 22 oz.
Intake Fitting 1/2" ACME 1/4" Flare



8711
Air Operated Light Duty Vacuum Pump
Air Disp. 1.3 CFM
Air Operated - Requires 4.5 cfm/90 psi shop air

8712
5 CFM Two Stage Vacuum Pump
Multi-refrigerant compatible.
Works with R12 & R134a.



Air Disp. 5 CFM
Motor Size 1/3 HP
Voltage 115V 60 Hz
Micron Rating ... 25 Microns
Oil Capacity 13.5 oz. (399ml)
Intake Fitting 1/2" ACME 1/4" Flare 3/8" Flare

8713
7 CFM Two Stage Vacuum Pump
Multi-refrigerant compatible.
Works with R12 & R134a.

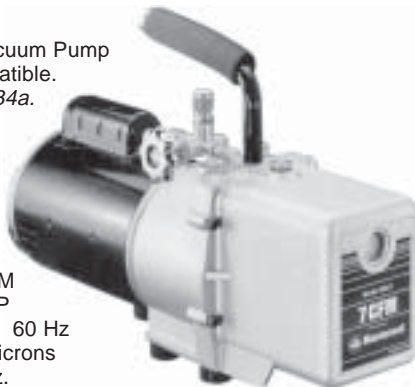

Air Disp. 7 CFM
Motor Size 1/2 HP
Voltage 115V 60 Hz
Micron Rating ... 25 Microns
Oil Capacity 22 oz.
Intake Fitting 1/2" ACME 1/4" Flare 3/8" Flare

8255 Gallon
8256 Quart
8257 12 oz.

Vacuum Pump Oil
Promotes internal sealing for good vacuum and absorbs unwanted vapor from evacuated units. Regular oil changes promote longer vacuum pump life.



8720
Vacuum Pump Fitting - Retro-Adapter to convert R12 pumps to R134a



8721
Vacuum Pump Fitting - Retro-Adapter to convert R12 pumps to R134a



8722
Vacuum Pump Fitting - "T" Style Retro-Adapter to convert R12 pumps to R134a

TOOLS and SERVICE ITEMS

TOOLS-SERVICE ITEMS

Clutch Plate Removal Tools



8940
SANDEN 505/507/508/510/575
708/709



8941
GM A6/R4



8942
FORD FS6
Chrysler C171/A590



8943
GM DA6/HR6/V5



8945
Clutch Remover Kit
Includes 8940/8941/8942/8943



8195
Deluxe Hub Puller/Installer Kit
• Kit contains a complete offering of A/C compressor clutch hub pullers and installers for GM, Ford, Chrysler and Imports.
• Includes a compressor identification chart and comes in a custom molded case.

Clutch Pulley Pullers

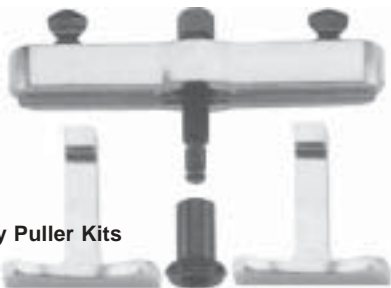

8196
Universal Clutch Pulley Puller Kits
Kit contains:
• Rotor and bearing pilot
• Universal puller body
• Universal puller arbor
• Universal remover jaws

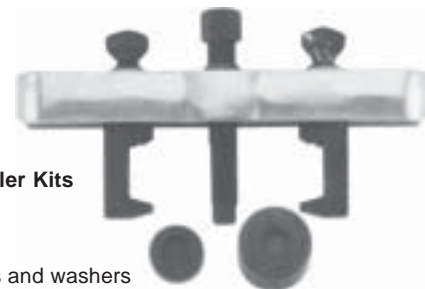

8197
Universal Pulley Puller Kits
Kit contains:
• Puller arbor
• Pulley removal jaws
• Set of thumb screws and washers
• GM pulley removal pilot
• GM pulley hub removal pilot
• GM puller body

Service Tool Sets



8181
Master Seal Service Tool Set
 Includes the tools necessary to service seals on all GM, Nippondenso, York, Tecumseh, and Sanden compressors.



8185
Zexel Seal and Clutch Tool Set
 Services standard Diesel Kiki compressor models: DKS12 and DKS15.
 Includes tool box and instructions.



8186
Master Sanden Compressor Tool Service Set
 All specialized tools necessary to service seal, clutch and clutch veering on Sanden 505, 507, 510 and 575 compressors.



8187
Ford FS-6 Nippondenso Compressor Tool Set
 Contains all the specialized tools required to service Nippondenso Compressors.



8188
Master Clutch Service Tool Set
 For Servicing Clutches on: GM A6, R4, DA6, R4, V5, Ford FS6, Chrysler C171, and Sanden Compressors.



Seal Replacement Tool Kits

- 8174** GM DA6 Carbon Seal Set
- 8175** CCI/Tecumseh Seal Set
- 8176** GM A6, R4, and late DA6/HR6 Seal Set
- 8177** Ford FS6 Seal Set
- 8178** Sanden 508/510 Seal Set
- 8179** Zexel Diesel Kiki Seal Set

TOOLS-SERVICE ITEMS