

Condensers

| | |
|---------------------------------|------------|
| Condenser Applications | 230 |
| Condenser Coils | 232 |
| Condenser Specifications | 243 |
| Multi-Flow Condensers | 246 |
| Mounting Hardware | 247 |
| Typical header Types | 247 |
| Service Tips | 247 |
| Condenser Fan Assemblies | 248 |

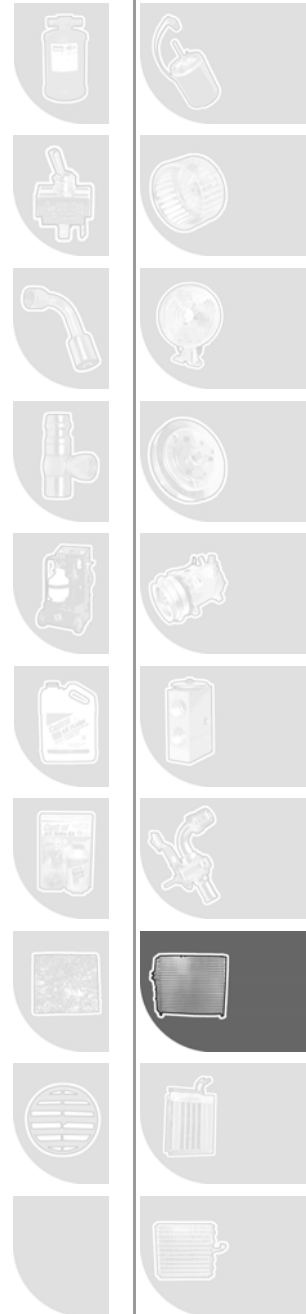

Condenser Quick Cross Reference and Application Guide

| PART NO. | OEM | OEM NO. | APPLICATION |
|----------|-----|---------|-------------|
|----------|-----|---------|-------------|

CASE

| | | | |
|---------|------|----------|--------------|
| 1599010 | CASE | 97213C2 | WHEEL LOADER |
| 1599017 | CASE | 298690A1 | SKID STEER |

CATERPILLAR

| | | | |
|---------|-------------|-------------|-------------|
| 1599018 | CATERPILLAR | 9X-3439 | ALL W/OEM # |
| 1599019 | CATERPILLAR | 166-5814 | ALL W/OEM # |
| 1599020 | CATERPILLAR | 124-8492 | ALL W/OEM # |
| 1599021 | CATERPILLAR | 115-4851 | ALL W/OEM # |
| 1599022 | CATERPILLAR | 9X-3450 | ALL W/OEM # |
| 1599023 | CATERPILLAR | 103-8519-04 | ALL W/OEM # |
| 1599024 | CATERPILLAR | 101-9619 | ALL W/OEM # |
| 1599025 | CATERPILLAR | 107-1995 | ALL W/OEM # |
| 1599026 | CATERPILLAR | 7G-3478 | ALL W/OEM # |
| 1599027 | CATERPILLAR | 111-8613 | ALL W/OEM # |
| 1599028 | CATERPILLAR | 7G-3480 | ALL W/OEM # |
| 1599029 | CATERPILLAR | 103-9527 | ALL W/OEM # |
| 1599030 | CATERPILLAR | 1Q-1934 | ALL W/OEM # |

CHEVY/GMC

| | | | |
|---------|-----------|------------------------------|--------------------------------------|
| 1510014 | CHEVY/GMC | 3058197 | SERIES 80-95 BRIGADIER, BRUIN MODELS |
| 1510016 | CHEVY/GMC | 3096190 | SERIES 40-75 |
| 1510012 | CHEVY/GMC | 3042163 | SERIES 80-95 BRIGADIER, BRUIN MODELS |
| 1510001 | CHEVY/GMC | 52471230 | C/K 10-35 |
| 1510002 | CHEVY/GMC | 52458717 | C,K SUBURBAN / PICKUP, BLAZER, TAHOE |
| 1510003 | CHEVY/GMC | 52455842 | C/K 10-35 |
| 1510004 | CHEVY/GMC | 3059855 | C/K 10-35 |
| 1510005 | CHEVY/GMC | 3053292 / 3053293 | R, V / PICKUP, BLAZER, SUBURBAN |
| 1510006 | CHEVY/GMC | 52457928 | G SERIES FULL SIZE VAN |
| 1510007 | CHEVY/GMC | 3053039 / 3055310 / 52450903 | G SERIES FULL SIZE VAN |
| 1510008 | CHEVY/GMC | 3057628 / 52450904 | G SERIES FULL SIZE VAN |
| 1510009 | CHEVY/GMC | 52474647 / 52462672 | S 10 PICKUP |
| 1510010 | CHEVY/GMC | 3048188 / 52456126 | S10 PICKUP |
| 1510011 | CHEVY/GMC | 52464973 | C SERIES |
| 1510013 | CHEVY/GMC | 3039456 | SERIES 80-95 BRIGADIER, BRUIN MODELS |
| 1510015 | CHEVY/GMC | 52450299 | SERIES 40-75 |

FORD

| | | | |
|---------|------|----------------------------|---------------|
| 1511001 | FORD | E8UZ-19712-B | E, F SERIES |
| 1511002 | FORD | F6TZ-19712-BA | F150 - 350 |
| 1511003 | FORD | E7HZ-19712-E | L SERIES |
| 1511004 | FORD | E7HZ-19712-G | L SERIES |
| 1511005 | FORD | F4HZ-19712-A | L SERIES |
| 1511006 | FORD | F2HZ-19712-A | L SERIES |
| 1511007 | FORD | F6HT-19710B-A | AEROMAX L8000 |
| 1511008 | FORD | E1HZ-19712-A | L SERIES |
| 1511009 | FORD | E4HZ-19712-C | L SERIES |
| 1511010 | FORD | E4HZ-19172-B | L SERIES |
| 1511011 | FORD | E7HZ-19712-A | C/CL/CLT/CT |
| 1511012 | FORD | E7HZ-19712-F | L SERIES |
| 1511013 | FORD | E8HZ-19712-B | C/CL/CLT/CT |
| 1511014 | FORD | F0HZ-19712-F | L SERIES |
| 1511015 | FORD | F0HZ-19712-D | C/CL/CLT/CT |
| 1599001 | FORD | F65Z-19712-ABC | F150 - 350 |
| 1511016 | FORD | E7TZ-19712-A, E9TZ-19712-B | F150 - 350 |

| PART NO. | OEM | OEM NO. | APPLICATION |
|----------|-----|---------|-------------|
|----------|-----|---------|-------------|

FREIGHTLINER

| | | | |
|---------|--------------|--------------------------|----------------------------|
| 1512001 | FREIGHTLINER | 22-39302-001 | FLD SERIES |
| 1512002 | FREIGHTLINER | 22-32466-001 | FLD SERIES |
| 1512003 | FREIGHTLINER | 22-42084-002 | C SERIES |
| 1512004 | FREIGHTLINER | A22-24885-0 | FLB SERIES |
| 1512005 | FREIGHTLINER | 22-43941-000 | FLD112 |
| 1512006 | FREIGHTLINER | A22-25339-000 | ALL W/OEM# |
| 1512007 | FREIGHTLINER | 681-830-00-20 | FLP, FLT SERIES |
| 1518001 | FREIGHTLINER | A22-14434-1, A22-25255-0 | FLC, W SERIES |
| 1599011 | FREIGHTLINER | 680-830-03-70 | FL SERIES (BUSINESS CLASS) |

INTERNATIONAL

| | | | |
|---------|---------------|--------------|-------------------|
| 1513001 | INTERNATIONAL | 3504377C1 | 9000 SERIES |
| 1513002 | INTERNATIONAL | 1618820C5 | ALL W/OEM# |
| 1513003 | INTERNATIONAL | 3504370C2 | ALL W/OEM# |
| 1513004 | INTERNATIONAL | 2009378C2 | 9300 SERIES |
| 1513005 | INTERNATIONAL | 2000994C3 | ALL W/OEM# |
| 1513006 | INTERNATIONAL | 3509453C1 | ALL W/OEM# |
| 1513007 | INTERNATIONAL | 1667340C5 | 4000 SERIES |
| 1513008 | INTERNATIONAL | 2000655C2 | 4000 SERIES |
| 1513009 | INTERNATIONAL | 2004801C3 | 2000, 8000 SERIES |
| 1513010 | INTERNATIONAL | 1652584C92 | 2000 SERIES |
| 1513011 | INTERNATIONAL | 1675462C2 | 8000 SERIES |
| 1513012 | INTERNATIONAL | 454625C3 | 4000 SERIES |
| 1513013 | INTERNATIONAL | 481954C5 | 4000 SERIES |
| 1513014 | INTERNATIONAL | 2505650C92 | 8000 SERIES |
| 1513016 | INTERNATIONAL | 1674253C2 | 8000 SERIES |
| 1513017 | INTERNATIONAL | 2004801C4 | 8000 SERIES |
| 1513018 | INTERNATIONAL | 1677378C93 | 9000 SERIES |
| 1513019 | INTERNATIONAL | 586908C92 | 9000 SERIES |
| 1513020 | INTERNATIONAL | 557335C91 | 9000 SERIES |
| 1513021 | INTERNATIONAL | 1649161C93 | 9000 SERIES |
| 1513022 | INTERNATIONAL | 501118C1, C3 | 9000 SERIES |
| 1513023 | INTERNATIONAL | 1619609C93 | 9000 SERIES |
| 1513024 | INTERNATIONAL | 501117C2 | 9000 SERIES |
| 1513025 | INTERNATIONAL | 1647142C91 | 9000 SERIES |
| 1513026 | INTERNATIONAL | 483479C2 | S, S2000 SERIES |
| 1513027 | INTERNATIONAL | 2507482C91 | ALL W/OEM # |
| 1513028 | INTERNATIONAL | 2586812C91 | ALL W/OEM # |

KENWORTH

| | | | |
|---------|----------|-------------|------------------------|
| 1514001 | KENWORTH | K122-51 | K100 |
| 1514002 | KENWORTH | K122-70 | K100 |
| 1514003 | KENWORTH | K122-47 | K100 |
| 1514004 | KENWORTH | K122-90 | C500 |
| 1514005 | KENWORTH | K122-81 | T600 GRILLDENSER |
| 1514006 | KENWORTH | K122-82 | T800 |
| 1514007 | KENWORTH | K122-93 | T450 |
| 1514008 | KENWORTH | K122-79 | T600 |
| 1514009 | KENWORTH | K122-84 | T800 |
| 1514011 | KENWORTH | K122-124 | T600,T800 |
| 1514012 | KENWORTH | K122-123 | T600 GRILLDENSER |
| 1514013 | KENWORTH | K122-102 | T800 W/DUAL PAS-SANGER |
| 1514014 | KENWORTH | K122-104 | T600,T800 |
| 1514015 | KENWORTH | K122-143 | T800W, C500W |
| 1514016 | KENWORTH | K122-128 | T300 |
| 1514017 | KENWORTH | K122-125 | T400, T600 |
| 1514018 | KENWORTH | K122-64 | W900 |
| 1514019 | KENWORTH | K122-62 | W900 GRILLDENSER |
| 1514020 | KENWORTH | K122-98 | W900 |
| 1514021 | KENWORTH | K122-121 | W900 |
| 1514022 | KENWORTH | 486684-5008 | T2000 |

Condenser Quick Cross Reference and Application Guide

| PART NO. | OEM | OEM NO. | APPLICATION |
|----------------|---------|-------------------------|------------------------|
| KOMATSU | | | |
| 1599031 | KOMATSU | 1439697H1, 1431742H2 | ALL W/OEM # |
| KYSOR | | | |
| 1517004 | KYSOR | 401031 | KYSOR |
| 1575001 | KYSOR | 401023 | KYSOR |
| 1575002 | KYSOR | 401024 | KYSOR |
| 1575002 | KYSOR | 401024 | KYSOR |
| 1575003 | KYSOR | 401025 | KYSOR |
| 1575004 | KYSOR | 401041 | KYSOR |
| 1575005 | KYSOR | 401043 | KYSOR |
| 1575006 | KYSOR | 401075 | KYSOR |
| 1575007 | KYSOR | 401077 | KYSOR |
| 1575008 | KYSOR | 401080 | KYSOR |
| 1575009 | KYSOR | 401102 | KYSOR |
| 1575010 | KYSOR | 401119 | KYSOR |
| 1575011 | KYSOR | 401054 | KYSOR |
| 1575013 | KYSOR | 401040 | KYSOR |
| 1575014 | KYSOR | 401121 | KYSOR |
| 1575015 | KYSOR | 401039 | KYSOR |
| 1575016 | KYSOR | 401114 | KYSOR |
| 1575017 | KYSOR | 401076 | KYSOR |
| 1575018 | KYSOR | 401094 | KYSOR |
| 1575019 | KYSOR | 401044 | KYSOR |
| 1575020 | KYSOR | 401109 | KYSOR |
| 1575022 | KYSOR | 401059 | KYSOR |
| 1575023 | KYSOR | 401065 | KYSOR |
| 1575024 | KYSOR | 401100 | KYSOR |
| 1599002 | KYSOR | 401034 | KYSOR |
| 1599004 | KYSOR | 401030 | KYSOR ROOFTOP KC100 |
| 1599005 | KYSOR | 401036 | KYSOR |
| 1599006 | KYSOR | 401029 | KYSOR |
| 1599007 | KYSOR | 401049 | KYSOR |
| 1599008 | KYSOR | 401052 | KYSOR |
| 1599009 | KYSOR | 401086 | KYSOR |
| 1599100 | KYSOR | 416825 | KYSOR |
| MACK | | | |
| 1515002 | MACK | 210RD411M | CH SERIES |
| 1515003 | MACK | 210RD412 | DH SERIES |
| 1515004 | MACK | 210RD510/54M | CH SERIES |
| 1515005 | MACK | 210RD56M | CH SERIES |
| 1515006 | MACK | 210RD418 | ALL W/OEM# |
| 1515007 | MACK | 210RD421M | CH SERIES |
| 1515008 | MACK | 210RD410M | DM,RB,RD SERIES |
| 1515009 | MACK | 210RD413 | MC,MR SERIES |
| 1515010 | MACK | 210RD45A | R,U,DM SERIES |
| 1515011 | MACK | 210RD49302P2 | RW SERIES |
| 1515012 | MACK | 210RD46AM | MH SERIES |

| PART NO. | OEM | OEM NO. | APPLICATION |
|---------------------|--------------|--------------|---|
| PETERBILT | | | |
| 1517001 | PETERBILT | 18-02074 | 359 SERIES |
| 1517003 | PETERBILT | RD4-3724-0 | 300 SERIES W/RED DOT COND. |
| 1517005 | PETERBILT | 18-03093 | 357,377,378,379,385 CONV. |
| 1517007 | PETERBILT | 18-03012 | 357,377,378,379,385 CONV. |
| 1517008 | PETERBILT | 18-03543 | 357,377,378,379,385 CONV. |
| 1517009 | PETERBILT | 18-03544 | 357,377,378,379,385 CONV. |
| 1517011 | PETERBILT | 18-04015 | 357,377,378,379,385 CONV. |
| 1517012 | PETERBILT | 1E4582 | 387 SERIES |
| 1599003 | PETERBILT | RD4-4161-0 | MID RANGER LOW CAB FORWARD |
| RED DOT | | | |
| 1517002 | RED DOT | RDG-7024-0 | RED DOT |
| UTILIMASTER | | | |
| 1599032 | UTILIMASTER | 401105 | VAN |
| VOLVO | | | |
| 1518003 | VOLVO | 61203-0003 | RBII, RCII, RXII SERIES |
| 1518005 | VOLVO | 61203-0031 | ALL W/OEM# R12 |
| 1518006 | VOLVO | 61203-0029 | ALL W/OEM# |
| 1518007 | VOLVO | 61203-3211 | ALL W/OEM# R12 |
| 1518008 | VOLVO | 8022509 | ALL W/OEM# |
| 1518009 | VOLVO | 8164786 | ALL W/OEM# & FIT- TINGS ON OPP. SIDE |
| 1518010 | VOLVO | 3092918 | VN SERIES |
| 1518011 | VOLVO | 8074693 | VN SERIES |
| 1518012 | VOLVO | 8157100 | ALL W/OEM# |
| 1518013 | VOLVO | 61203-3207 | ALL W/OEM# |
| 1518014 | VOLVO | 61203-0012 | ALL W/O AIR TO AIR AFTERCOOLER |
| 1518015 | VOLVO | 61203-3209 | ALL W/OEM# |
| 1518016 | VOLVO | 61203-3203 | ALL W/OEM# |
| 1518017 | VOLVO | 3086000 | AUTOCAR |
| 1518018 | VOLVO | 61203-3210 | ALL W/OEM # |
| 1518019 | VOLVO | 61203-0030 | ALL W/OEM # |
| 1599005 | VOLVO | 61203-3001,2 | RBII, WAH, WCA, WG, WIA |
| WESTERN STAR | | | |
| 1519001 | WESTERN STAR | 61203-3403 | ALL W/OEM# |



Condenser Coils

CONDENSERS

Part No. 1510001



Length (A) **28 1/2"**
 Width (B) **15 1/2"**
 Thickness **1"**
 Inlet **N/A**
 Outlet **N/A**

Part No. 1510002

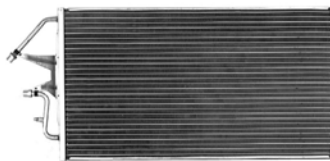

Length (A) **28"**
 Width (B) **16"**
 Thickness **1 1/8"**
 Inlet **N/A**
 Outlet **N/A**

Part No. 1510003

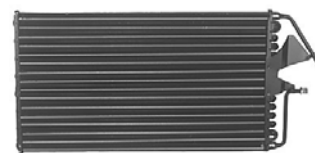

Length (A) **28 1/2"**
 Width (B) **16"**
 Thickness **1 1/8"**
 Inlet **N/A**
 Outlet **N/A**

Part No. 1510004

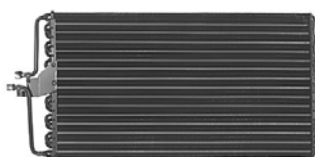

Length (A) **28 1/2"**
 Width (B) **16"**
 Thickness **1 1/8"**
 Inlet **N/A**
 Outlet **N/A**

Part No. 1510005

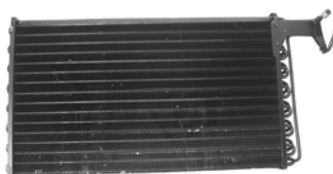

Length (A) **26 3/4"**
 Width (B) **16"**
 Thickness **1 3/8"**
 Inlet **N/A**
 Outlet **N/A**

Part No. 1510006



Length (A) **31 1/2"**
 Width (B) **14"**
 Thickness **1 1/2"**
 Inlet **N/A**
 Outlet **N/A**

Part No. 1510007

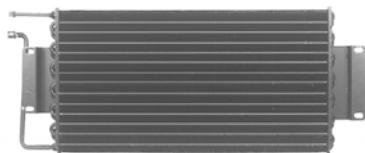

Length (A) **26 3/8"**
 Width (B) **14"**
 Thickness **1 1/4"**
 Inlet **N/A**
 Outlet **N/A**

Part No. 1510008

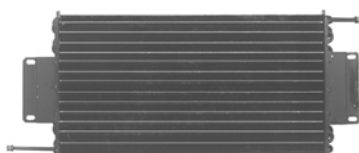

Length (A) **26 3/8"**
 Width (B) **14"**
 Thickness **1 1/4"**
 Inlet **N/A**
 Outlet **N/A**

Part No. 1510009



Length (A) **26 1/4"**
 Width (B) **14"**
 Thickness **1 1/8"**
 Inlet **N/A**
 Outlet **N/A**

Part No. 1510010

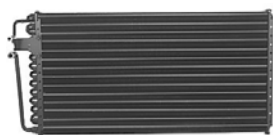

Length (A) **26 1/2"**
 Width (B) **14"**
 Thickness **1 3/8"**
 Inlet **N/A**
 Outlet **N/A**

Part No. 1510011

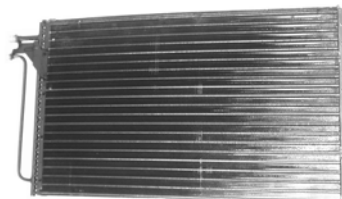

Length (A) **N/A**
 Width (B) **N/A**
 Thickness **N/A**
 Inlet **N/A**
 Outlet **N/A**

Part No. 1510013



Length (A) **36 1/2"**
 Width (B) **22"**
 Thickness **3/8"**
 Inlet **Male O-Ring**
 Outlet **Male O-Ring**

Part No. 1510014



Length (A) **36 1/2"**
 Width (B) **22"**
 Thickness **3/4"**
 Inlet **Male O-Ring**
 Outlet **Male O-Ring**

Part No. 1510015

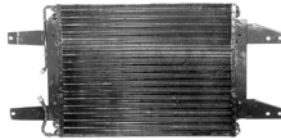

Length (A) **24"**
 Width (B) **18"**
 Thickness **1 3/8"**
 Inlet **Male O-Ring**
 Outlet **Male O-Ring**

Part No. 1510016

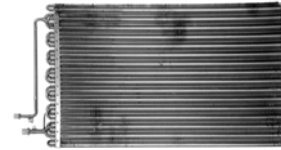

Length (A) **25"**
 Width (B) **16"**
 Thickness **1"**
 Inlet **Male O-Ring**
 Outlet **Male O-Ring**

Part No. 1511001

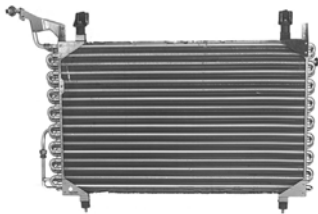

Length (A) **27"**
 Width (B) **17 1/4"**
 Thickness **1 1/4"**
 Inlet **N/A**
 Outlet **N/A**

Part No. 1511002

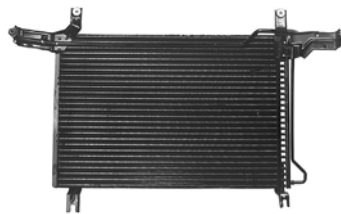

Length (A) **24 3/4"**
 Width (B) **17 1/2"**
 Thickness **1"**
 Inlet **N/A**
 Outlet **N/A**

Part No. 1511004



Length (A) **31 1/2"**
 Width (B) **25 3/4"**
 Thickness **N/A**
 Inlet **Male O-Ring**
 Outlet **Male O-Ring**

Part No. 1511005



Length (A) **27"**
 Width (B) **22"**
 Thickness **1"**
 Inlet **Male O-Ring**
 Outlet **Male O-Ring**

Part No. 1511006



Length (A) **26 1/2"**
 Height (B): **21"**
 Thickness **1"**
 Inlet **No. 8 FSL**
 Outlet **No. 8 FSL**

Part No. 1511008



Length (A) **32"**
 Width (B) **22"**
 Thickness **3/4"**
 Inlet **Male O-Ring**
 Outlet **Male O-Ring**

Part No. 1511009



Length (A) **32"**
 Height (B): **22"**
 Thickness **3/4"**
 Inlet **Female O-Ring**
 Outlet **Female O-Ring-**

Part No. 1511010

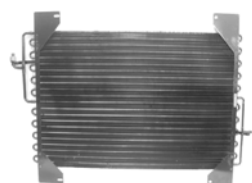

Length (A) **32"**
 Width (B) **22"**
 Thickness **3/4"**
 Inlet **Female O-Ring**
 Outlet **Female O-Ring**

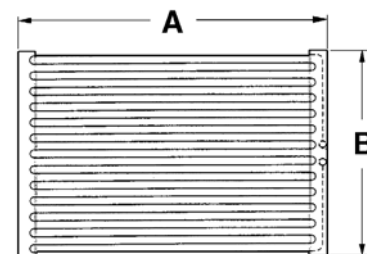

Condenser Coils

CONDENSERS

Part No. 1511011

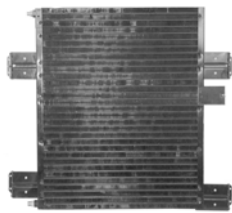

Length (A) **24 3/4"**
 Width (B) **32"**
 Thickness **1"**
 Inlet **Male O-Ring**
 Outlet **Male O-Ring**

Part No. 1511012

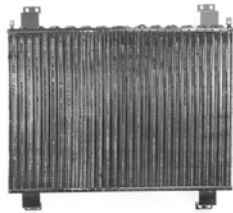

Length (A) **29"**
 Width (B) **19 3/4"**
 Thickness **1"**
 Inlet **Male O-Ring**
 Outlet **Male O-Ring**

Part No. 1511013



Length (A) **21"**
 Height (B): **18"**
 Thickness **1"**
 Inlet **N/A**
 Outlet **N/A**

Part No. 1511014

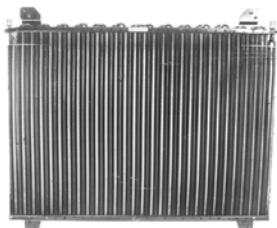

Length (A) **29"**
 Width (B) **20"**
 Thickness **1"**
 Inlet **Male O-Ring**
 Outlet **Male O-Ring**

Part No. 1511015

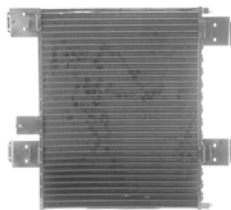

Length (A) **29 3/4"**
 Width (B) **32 1/8"**
 Thickness **1"**
 Inlet **Male O-Ring**
 Outlet **Male O-Ring**

Part No. 1512003



Length (A) **34"**
 Width (B) **20"**
 Thickness **1"**
 Inlet **N/A**
 Outlet **N/A**

Part No. 1512004

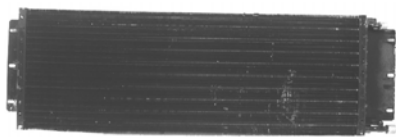

Length (A) **24 1/2"**
 Width (B) **15"**
 Thickness **1 3/8"**
 Inlet **Male O-Ring**
 Outlet **Male O-Ring**

Part No. 1512006

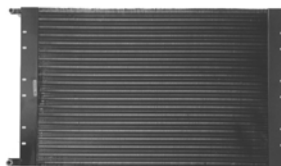

Length (A) **24 1/2"**
 Width (B) **15"**
 Thickness **3/4"**
 Inlet **Male O-Ring**
 Outlet **Male O-Ring**

Part No. 1512007

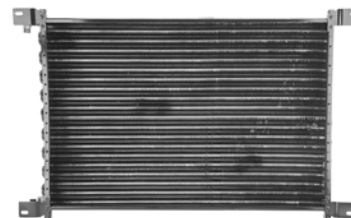

Length (A) **29 1/4"**
 Width (B) **20"**
 Thickness **1"**
 Inlet **Male O-Ring**
 Outlet **Male O-Ring**

Part No. 1513001

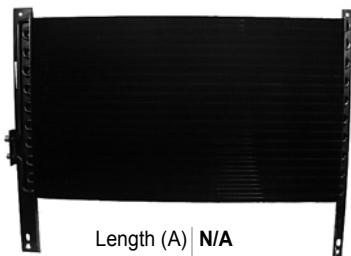

Length (A) **N/A**
 Width (B) **N/A**
 Thickness **N/A**
 Inlet **N/A**
 Outlet **N/A**

Part No. 1513002



Length (A) **N/A**
 Width (B) **N/A**
 Thickness **N/A**
 Inlet **N/A**
 Outlet **N/A**

Part No. 1513004



Length (A) **26"**
 Width (B) **27"**
 Thickness **3/4"**
 Inlet **No. 8 (3/4"-16) Male O-Ring**
 Outlet **No. 6 (5/8"-18) Male O-Ring**

Part No. 1513005



Length (A) **N/A**
 Width (B) **N/A**
 Thickness **N/A**
 Inlet **N/A**
 Outlet **N/A**

Part No. 1513007

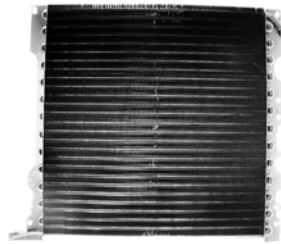

Length (A) **30 1/2"**
 Width (B) **27"**
 Thickness **29/32"**
 Inlet **No. 8 (3/4"-16) Male O-Ring**
 Outlet **No. 6 (5/8"-18) Male O-Ring**

Part No. 1513008



Length (A) **27 1/2"**
 Width (B) **24"**
 Thickness **1"**
 Inlet **N/A**
 Outlet **N/A**

Part No. 1513010



Length (A) **28"**
 Width (B) **25"**
 Thickness **N/A**
 Inlet **N/A**
 Outlet **N/A**

Part No. 1513011

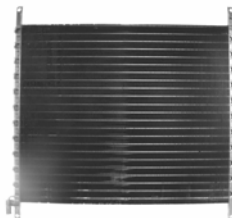

Length (A) **29"**
 Width (B) **24"**
 Thickness **1"**
 Inlet **No. 8 (3/4"-16) Male O-Ring**
 Outlet **No. 6 (5/8"-18) Male O-Ring**

Part No. 1513012

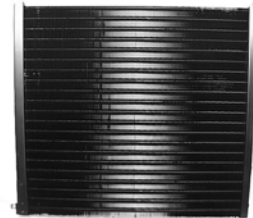

Length (A) **28 1/2"**
 Width (B) **26"**
 Thickness **1 1/2"**
 Inlet **No. 8 (3/4"-16) Male O-Ring**
 Outlet **No. 6 (5/8"-18) Male O-Ring**

Part No. 1513013



Length (A) **27 1/4"**
 Width (B) **22"**
 Thickness **1 1/2"**
 Inlet **No. 8 (3/4"-16) Male O-Ring**
 Outlet **No. 6 (5/8"-18) Male O-Ring**

Part No. 1513014



Length (A) **N/A**
 Width (B) **N/A**
 Thickness **N/A**
 Inlet **N/A**
 Outlet **N/A**

Part No. 1513017

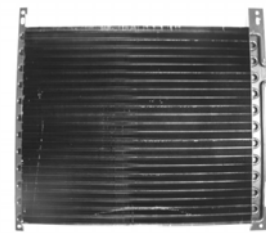

Length (A) **31 3/8"**
 Width (B) **24"**
 Thickness **7/8"**
 Inlet **Male O-Ring**
 Outlet **Male O-Ring**

Part No. 1513018



Length (A) **28 3/4"**
 Width (B) **16"**
 Thickness **N/A**
 Inlet **N/A**
 Outlet **N/A**

Part No. 1513019



Length (A) **36"**
 Width (B) **22 1/2"**
 Thickness **3/4"**
 Inlet **No. 8 (3/4"-16) Male O-Ring**
 Outlet **No. 6 (5/8"-18) Male O-Ring**

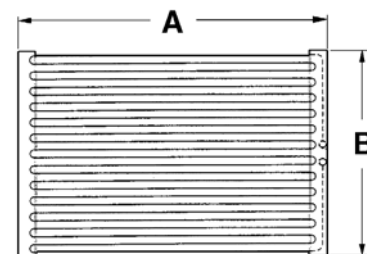

Condenser Coils

CONDENSERS

Part No. 1513020



Length (A) **29"**
 Width (B) **26"**
 Thickness **3/4"**
 Inlet **No. 8 (3/4"-16) Male O-Ring**
 Outlet **No. 6 (5/8"-18) Male O-Ring**

Part No. 1513021



Length (A) **N/A"**
 Width (B) **16"**
 Thickness **1 1/4"**
 Inlet **No. 8 (3/4"-16) Male O-Ring**
 Outlet **No. 6 (5/8"-18) Male O-Ring**

Part No. 1513022

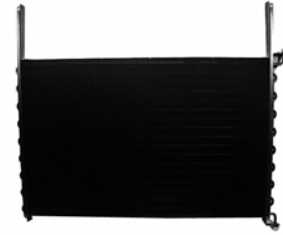

Length (A) **36"**
 Width (B) **22 1/2"**
 Thickness **1"**
 Inlet **No. 8 (3/4"-16) Male O-Ring**
 Outlet **No. 6 (5/8"-18) Male O-Ring**

Part No. 1513024



Length (A) **29"**
 Width (B) **27 3/4"**
 Thickness **1"**
 Inlet **No. 8 (3/4"-16) Male O-Ring**
 Outlet **No. 6 (5/8"-18) Male O-Ring**

Part No. 1513025



Length (A) **27"**
 Width (B) **28"**
 Thickness **3/4"**
 Inlet **No. 8 (3/4"-16) Male O-Ring**
 Outlet **No. 6 (5/8"-18) Male O-Ring**

Part No. 1513026



Length (A) **27"**
 Width (B) **23"**
 Thickness **1"**
 Inlet **Male O-Ring**
 Outlet **Male O-Ring**

Part No. 1513027



Length (A) **21 53/64"**
 Width (B) **19 37/64"**
 Thickness **53/64"**
 Inlet **PAD mount**
 Outlet **PAD mount**

Part No. 1513028

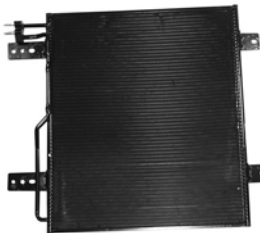

Length (A) **21 23/64"**
 Width (B) **24 25/64"**
 Thickness **5/8"**
 Inlet **PAD mount**
 Outlet **PAD mount**

Part No. 1514002



Length (A) **34 19/64"**
 Width (B) **33 3/8"**
 Thickness **13/16"**
 Inlet **No. 8 (3/4"-16) Male O-Ring**
 Outlet **No. 6 (5/8"-18) Male O-Ring**

Part No. 1514003

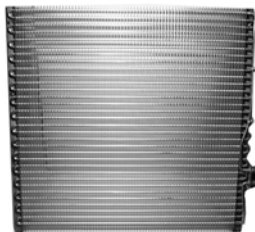

Length (A) **34 5/16"**
 Width (B) **33 3/8"**
 Thickness **3/4"**
 Inlet **No. 8 (3/4"-16) Male O-Ring**
 Outlet **No. 6 (5/8"-18) Male O-Ring**

Part No. 1514005

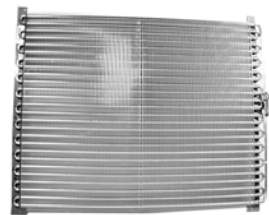

Length (A) **33 17/32"**
 Width (B) **27 7/8"**
 Thickness **15/16"**
 Inlet **No. 8 (3/4"-16) Male O-Ring**
 Outlet **No. 6 (5/8"-18) Male O-Ring**

Part No. 1514006



Length (A) **41 13/16"**
 Width (B) **33 3/8"**
 Thickness **27/32"**
 Inlet **No. 8 (3/4"-16) Male O-Ring**
 Outlet **No. 6 (5/8"-18) Male O-Ring**

Part No. 1514007

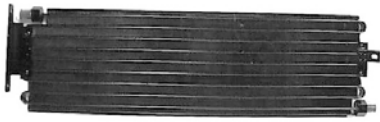

Length (A) **30 21/32"**
 Width (B) **8 15/32"**
 Thickness **1 1/4"**
 Inlet **No. 8 (3/4"-16) Male O-Ring**
 Outlet **No. 6 (5/8"-18) Male O-Ring**

Part No. 1514008



Length (A) **33 5/8"**
 Width (B) **35 13/16"**
 Thickness **51/94"**
 Inlet **No. 8 (3/4"-16) Male O-Ring**
 Outlet **No. 6 (5/8"-18) Male O-Ring**

Part No. 1514011



Length (A) **36 11/32"**
 Width (B) **42 1/8"**
 Thickness **51/64"**
 Inlet **No. 8 (3/4"-16) Male O-Ring**
 Outlet **No. 6 (5/8"-18) Male O-Ring**

Part No. 1514012

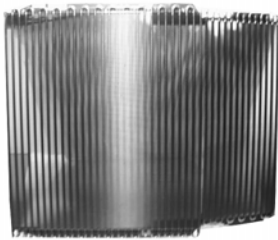

Length (A) **36 11/32"**
 Width (B) **42 1/8"**
 Thickness **51/64"**
 Inlet **No. 8 (3/4"-16) Male O-Ring**
 Outlet **No. 6 (5/8"-18) Male O-Ring**

Part No. 1514013

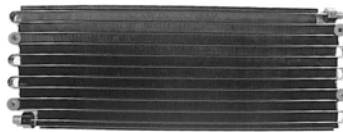

Length (A) **41 13/6"**
 Width (B) **29"**
 Thickness **59/64"**
 Inlet **No. 8 (3/4"-16) Male O-Ring**
 Outlet **No. 6 (5/8"-18) Male O-Ring**

Part No. 1514014



Length (A) **29 5/8"**
 Width (B) **10 5/16"**
 Thickness **1 9/32"**
 Inlet **No. 8 (3/4"-16) Male O-Ring**
 Outlet **No. 6 (5/8"-18) Male O-Ring**

Part No. 1514015



Length (A) **32 1/12"**
 Width (B) **20 11/16"**
 Thickness **45/64"**
 Inlet **No. 8 (3/4"-16) Male O-Ring**
 Outlet **No. 6 (5/8"-18) Male O-Ring**

Part No. 1514016



Length (A) **32 9/32"**
 Width (B) **17 41/64"**
 Thickness **1 1/4"**
 Inlet **No. 8 (3/4"-16) Male O-Ring**
 Outlet **No. 6 (5/8"-18) Male O-Ring**

Part No. 1514017

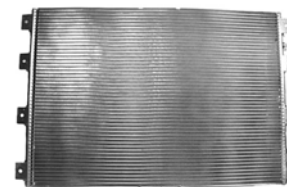

Length (A) **32 1/2"**
 Width (B) **20 11/16"**
 Thickness **45/64"**
 Inlet **No. 8 (3/4"-16) Male O-Ring**
 Outlet **No. 6 (5/8"-18) Male O-Ring**

Part No. 1514018

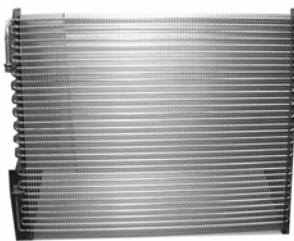

Length (A) **43 7/32"**
 Width (B) **36"**
 Thickness **3/4"**
 Inlet **No. 8 (3/4"-16) Male O-Ring**
 Outlet **No. 6 (5/8"-18) Male O-Ring**

Part No. 1514019

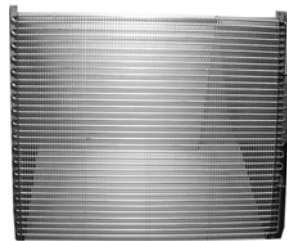

Length (A) **43 1/2"**
 Width (B) **38 3/32"**
 Thickness **27/32"**
 Inlet **No. 8 (3/4"-16) Male O-Ring**
 Outlet **No. 6 (5/8"-18) Male O-Ring**

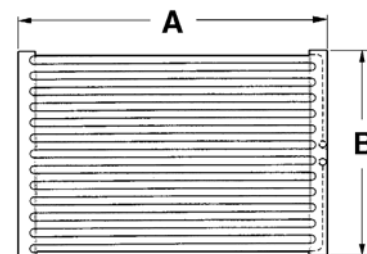

Condenser Coils

CONDENSERS

Part No. 1514020



Length (A) **39 3/4"**
 Width (B) **36 21/32"**
 Thickness **53/64"**
 Inlet **No. 8 (3/4"-16) Male O-Ring**
 Outlet **No. 6 (5/8"-18) Male O-Ring**

Part No. 1514021

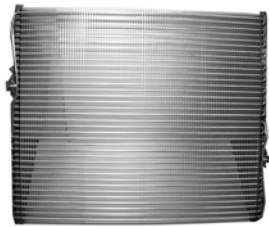

Length (A) **43 15/32"**
 Width (B) **38 3/32"**
 Thickness **27/32"**
 Inlet **No. 8 (3/4"-16) Male O-Ring**
 Outlet **No. 6 (5/8"-18) Male O-Ring**

Part No. 1514022

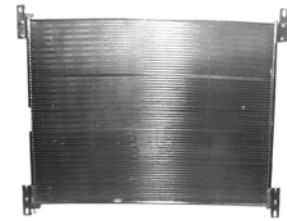

Length (A) **31"**
 Width (B) **23 3/4"**
 Thickness **3/4"**
 Inlet **Block Fittings**
 Outlet **Block Fittings**

Part No. 1515002

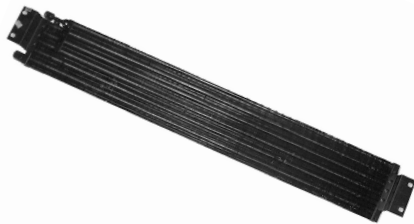

Length (A) **6 1/2"**
 Width (B) **39 1/2"**
 Thickness **1"**
 Inlet **N/A**
 Outlet **N/A**

Part No. 1515003



Length (A) **24"**
 Width (B) **25"**
 Thickness **1"**
 Inlet **Male O-Ring**
 Outlet **Male O-Ring**

Part No. 1515004



Length (A) **28"**
 Width (B) **23"**
 Thickness **1"**
 Inlet **Male O-Ring**
 Outlet **Male O-Ring**

Part No. 1515008

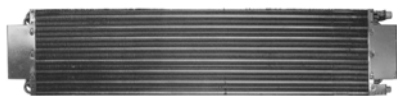

Length (A) **32"**
 Width (B) **8"**
 Thickness **1"**
 Inlet **Male O-Ring**
 Outlet **Male O-Ring**

Part No. 1515009

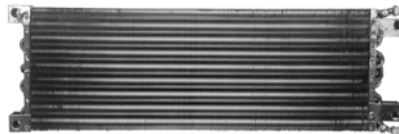

Length (A) **24 1/2"**
 Width (B) **9"**
 Thickness **2 5/8"**
 Inlet **Male O-Ring**
 Outlet **Male O-Ring**

Part No. 1515010

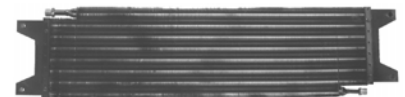

Length (A) **28 1/4"**
 Width (B) **8"**
 Thickness **1 3/8"**
 Inlet **Male O-Ring**
 Outlet **Male O-Ring**

Part No. 1515011

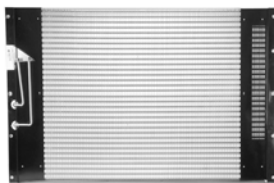

Length (A) **48"**
 Width (B) **33"**
 Thickness **3/4"**
 Inlet **Male O-Ring**
 Outlet **Male O-Ring**

Part No. 1515012



Length (A) **31 1/2"**
 Width (B) **8"**
 Thickness **1"**
 Inlet **Male O-Ring**
 Outlet **Male O-Ring**

Part No. 1517001



Length (A) **39 7/8"**
 Width (B) **32"**
 Thickness **3/4"**
 Inlet **No. 8 (3/4"-16) Male O-Ring**
 Outlet **No. 6 (5/8"-18) Male O-Ring**

Part No. 1517003

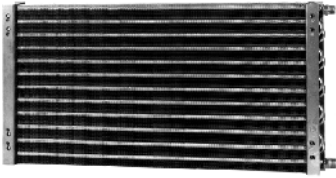

Length (A) **25"**
 Width (B) **12 1/4"**
 Thickness **1 3/4"**
 Inlet **No. 8 (3/4"-16) Male O-Ring**
 Outlet **No. 6 (5/8"-18) Male O-Ring**

Part No. 1517004



Length (A) **18"**
 Width (B) **27 3/16"**
 Thickness **2 1/4"**
 Inlet **N/A**
 Outlet **N/A**

Part No. 1517007



Length (A) **31 5/8"**
 Width (B) **8 19/32"**
 Thickness **13/16"**
 Inlet **No. 8 (3/4"-16) Male O-Ring**
 Outlet **No. 6 (5/8"-18) Male O-Ring**

Part No. 1517008



Length (A) **32 45/64"**
 Width (B) **8 7/16"**
 Thickness **1 1/8"**
 Inlet **No. 8 (3/4"-16) Male O-Ring**
 Outlet **No. 6 (5/8"-18) Male O-Ring**

Part No. 1517009

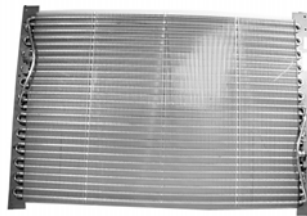

Length (A) **29 3/8"**
 Width (B) **10 5/16"**
 Thickness **1 1/8"**
 Inlet **No. 8 (3/4"-16) Male O-Ring**
 Outlet **No. 6 (5/8"-18) Male O-Ring**

Part No. 1517011



Length (A) **31"**
 Width (B) **33 5/32"**
 Thickness **1 1/4"**
 Inlet **No. 8 (3/4"-16) Male O-Ring**
 Outlet **No. 6 (5/8"-18) Male O-Ring**

Part No. 1517012

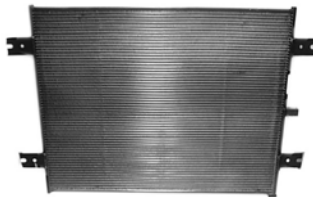

Length (A) **N/A**
 Width (B) **N/A**
 Thickness **N/A**
 Inlet **N/A**
 Outlet **N/A**

Part No. 1518001



Length (A) **27 1/4"**
 Width (B) **14 3/4"**
 Thickness **3/4"**
 Inlet **No. 8 (3/4"-16) Male O-Ring**
 Outlet **No. 6 (5/8"-18) Male O-Ring**

Part No. 1518005

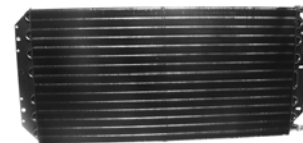

Length (A) **29**
 Width (B) **15**
 Thickness **7/8**
 Inlet **N/A**
 Outlet **N/A**

Part No. 1518006

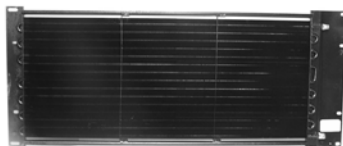

Length (A) **36**
 Width (B) **15**
 Thickness **7/8**
 Inlet **N/A**
 Outlet **N/A**

Part No. 1518007

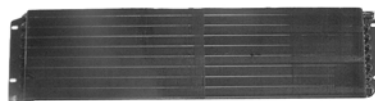

Length (A) **33"**
 Width (B) **9"**
 Thickness **1 3/4"**
 Inlet **No. 8 (3/4"-16) Male O-Ring**
 Outlet **No. 6 (5/8"-18) Male O-Ring**

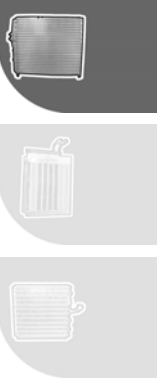
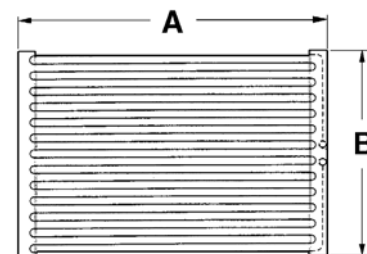

Condenser Coils

CONDENSERS

Part No. 1518008

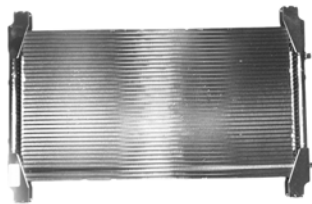

Length (A) **26 1/4**
 Width (B) **14 1/2**
 Thickness **1**
 Inlet **N/A**
 Outlet **N/A**

Part No. 1518009

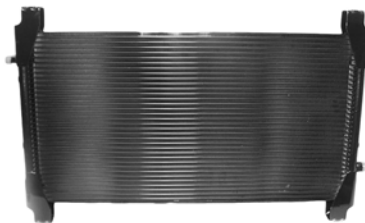

Length (A) **26 1/4**
 Width (B) **15**
 Thickness **1 3/8**
 Inlet **N/A**
 Outlet **N/A**

Part No. 1518010



Length (A) **37"**
 Width (B) **16 1/4"**
 Thickness **7/8"**
 Inlet **No. 8 (3/4"-16) Male O-Ring**
 Outlet **No. 6 (5/8"-18) Male O-Ring**

Part No. 1518011



Length (A) **N/A**
 Width (B) **N/A**
 Thickness **N/A**
 Inlet **N/A**
 Outlet **N/A**

Part No. 1518014

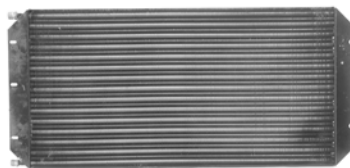

Length (A) **29"**
 Width (B) **15"**
 Thickness **3/4"**
 Inlet **Male O-Ring**
 Outlet **Male O-Ring**

Part No. 1518015



Length (A) **29"**
 Width (B) **15"**
 Thickness **3/4"**
 Inlet **Male O-Ring**
 Outlet **Male O-Ring**

Part No. 1518016

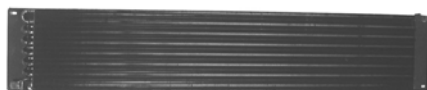

Length (A) **38"**
 Width (B) **8"**
 Thickness **1 3/8"**
 Inlet **Male O-Ring**
 Outlet **Male O-Ring**

Part No. 1518017

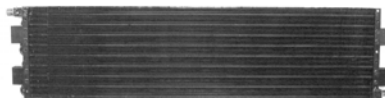

Length (A) **33 1/2"**
 Width (B) **9"**
 Thickness **1"**
 Inlet **Male O-Ring**
 Outlet **Male O-Ring**

Part No. 1575001



Length (A) **23 51/64"**
 Width (B) **14 45/64"**
 Thickness **3/4"**
 Inlet **No. 8 (3/4"-16) Male O-Ring**
 Outlet **No. 6 (5/8"-18) Male O-Ring**

Part No. 1575002

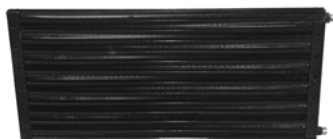

Length (A) **29 51/64"**
 Width (B) **13 19/32"**
 Thickness **3/4"**
 Inlet **N/A**
 Outlet **N/A**

Part No. 1575003



Length (A) **35 51/64"**
 Width (B) **11 1/2"**
 Thickness **3/4"**
 Inlet **N/A**
 Outlet **N/A**

Part No. 1575004



Length (A) **29 41/64"**
 Width (B) **10"**
 Thickness **3"**
 Inlet **No. 8 (3/4"-16) Male O-Ring**
 Outlet **No. 6 (5/8"-18) Male O-Ring**

Part No. 1575005

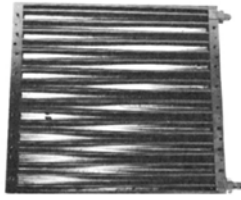

Length (A) **20"**
 Width (B) **18 3/32"**
 Thickness **1 3/32"**
 Inlet **N/A**
 Outlet **N/A**

Part No. 1575006



Length (A) **32 51/64"**
 Width (B) **9 13/32"**
 Thickness **2"**
 Inlet **N/A**
 Outlet **N/A**

Part No. 1575007



Length (A) **23 1/2"**
 Width (B) **12"**
 Thickness **1 1/2"**
 Inlet **No. 8 (3/4"-16) Male O-Ring**
 Outlet **No. 6 (5/8"-18) Male O-Ring**

Part No. 1575008

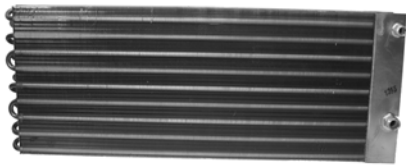

Length (A) **23 51/64"**
 Width (B) **9"**
 Thickness **2 5/8"**
 Inlet **No. 8 (3/4"-16) Male O-Ring**
 Outlet **No. 6 (5/8"-18) Male O-Ring**

Part No. 1575009

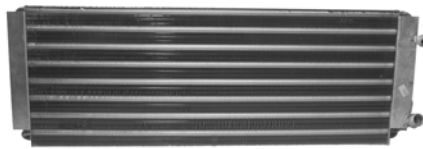

Length (A) **23 15/16"**
 Width (B) **8 1/8"**
 Thickness **1 7/8"**
 Inlet **No. 8 (3/4"-16) Male O-Ring**
 Outlet **No. 6 (5/8"-18) Male O-Ring**

Part No. 1575010

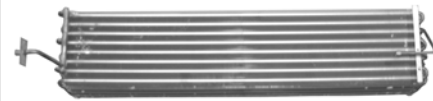

Length (A) **45"**
 Width (B) **10"**
 Thickness **6 31/64"**
 Inlet **No. 8 (3/4"-16) Male O-Ring**
 Outlet **No. 6 (5/8"-18) Male O-Ring**

Part No. 1575013



Length (A) **29 1/2"**
 Width (B) **20 1/3"**
 Thickness **2 1/4"**
 Inlet **No. 8 (3/4"-16) Male O-Ring**
 Outlet **No. 6 (5/8"-18) Male O-Ring**

Part No. 1575017

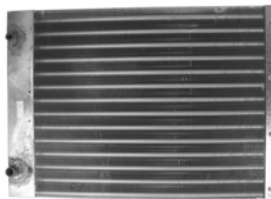

Length (A) **20"**
 Width (B) **14"**
 Thickness **1 47/64"**
 Inlet **No. 8 (3/4"-16) Male O-Ring**
 Outlet **No. 6 (5/8"-18) Male O-Ring**

Part No. 1599001



Length (A) **32 1/4"**
 Width (B) **16 7/8"**
 Thickness **1"**
 Inlet **N/A**
 Outlet **N/A**

Part No. 1599002

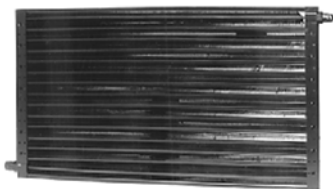

Length (A) **27 1/4"**
 Width (B) **14 3/4"**
 Thickness **3/4"**
 Inlet **Male O-Ring**
 Outlet **Male O-Ring**

Part No. 1599003

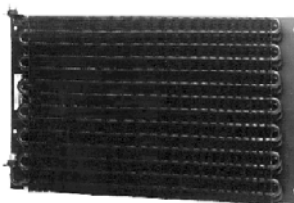

Length (A) **24 7/16"**
 Width (B) **14 1/8"**
 Thickness **1"**
 Inlet **No. 8 (3/4"-16) Male O-Ring**
 Outlet **No. 6 (5/8"-18) Male O-Ring**

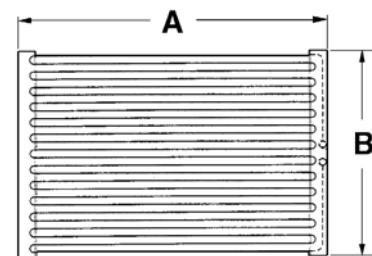

Condenser Coils

Part No. 1599004

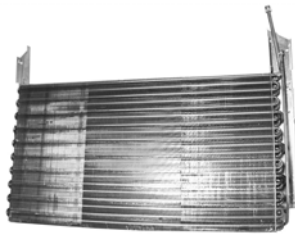

Length (A) **36"**
 Width (B) **20"**
 Thickness **2 1/4"**
 Inlet **N/A**
 Outlet **N/A**

Part No. 1599005

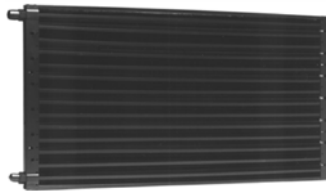

Length (A) **29 3/4"**
 Width (B) **15 3/4"**
 Thickness **3/4"**
 Inlet **No. 8 (3/4"-16) Male O-Ring**
 Outlet **No. 6 (5/8"-18) Male O-Ring**

Part No. 1599006



Length (A) **23 15/16"**
 Width (B) **6 1/2"**
 Thickness **2"**
 Inlet **No. 8 (3/4"-16) Male O-Ring**
 Outlet **No. 6 (5/8"-18) Male O-Ring**

Part No. 1599007

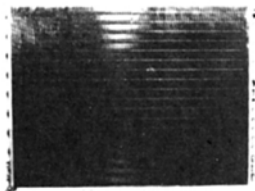

Length (A) **28 51/64"**
 Width (B) **28 45/64"**
 Thickness **1 3/32"**
 Inlet **No. 8 (3/4"-16) Male O-Ring**
 Outlet **No. 6 (5/8"-18) Male O-Ring**

Part No. 1599008

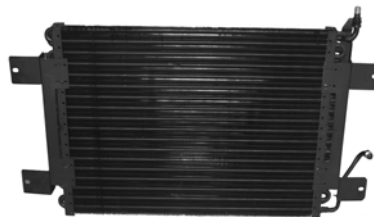

Length (A) **32 11/16"**
 Width (B) **17 7/8"**
 Thickness **1 3/8"**
 Inlet **No. 10 Hose Barbed**
 Outlet **11/16" Male Inverted Thread**

Part No. 1599009



Length (A) **29 51/64"**
 Width (B) **19 51/64"**
 Thickness **27/32"**
 Inlet **1/2" Male O-Ring**
 Outlet **3/8" Male O-Ring**

Part No. 1599010

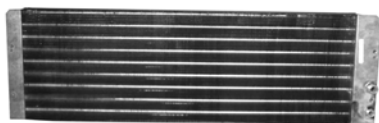

Length (A) **30 1/4"**
 Width (B) **9"**
 Thickness **2 19/32"**
 Inlet **No. 8 (3/4"-16) Male O-Ring**
 Outlet **No. 6 (5/8"-18) Male O-Ring**

Part No. 1599011



Length (A) **27"**
 Width (B) **20"**
 Thickness **1 1/2"**
 Inlet **Male O-Ring**
 Outlet **Male O-Ring**

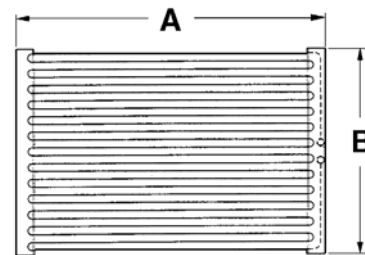

CONDENSERS



Condenser Coil Specifications

| Length (A) | Width (B) | Thickness | Inlet | Outlet | Part No. |
|------------|-----------|-----------|-----------------------------|-----------------------------|----------|
| 28 1/2" | 15 1/2" | 1" | N/A | N/A | 1510001 |
| 28" | 16" | 1 1/8" | N/A | N/A | 1510002 |
| 28 1/2" | 16" | 1 1/8" | N/A | N/A | 1510003 |
| 28 1/2" | 16" | 1 1/8" | N/A | N/A | 1510004 |
| 26 3/4" | 16" | 1 3/8" | N/A | N/A | 1510005 |
| 31 1/2" | 14" | 1 1/2" | N/A | N/A | 1510006 |
| 26 3/8" | 14" | 1 1/4" | N/A | N/A | 1510007 |
| 26 3/8" | 14" | 1 1/4" | N/A | N/A | 1510008 |
| 26 1/4" | 14" | 1 1/8" | N/A | N/A | 1510009 |
| 26 1/2" | 14" | 1 3/8" | N/A | N/A | 1510010 |
| N/A | N/A | N/A | N/A | N/A | 1510011 |
| 36 1/2" | 22" | 3/4" | Male O-Ring | Male O-Ring | 1510013 |
| 36 1/2" | 22" | 3/4" | Male O-Ring | Male O-Ring | 1510014 |
| 24" | 18" | 1 3/8" | Male O-Ring | Male O-Ring | 1510015 |
| 25" | 16" | 1" | Male O-Ring | Male O-Ring | 1510016 |
| 27" | 17 1/4" | 1 1/4" | N/A | N/A | 1511001 |
| 24 3/4" | 17 1/2" | 1" | N/A | N/A | 1511002 |
| 31 1/2" | 25 3/4" | N/A | Male O-Ring | Male O-Ring | 1511004 |
| 27" | 22" | 1" | Male O-Ring | Male O-Ring | 1511005 |
| 26 1/2" | 21" | 1" | No. 8 Female Spring Lock | No. 8 Female Spring Lock | 1511006 |
| 32" | 22" | 3/4" | Male O-Ring | Male O-Ring | 1511008 |
| 32" | 22" | 3/4" | Female O-Ring | Female O-Ring | 1511009 |
| 32" | 22" | 3/4" | Female O-Ring | Female O-Ring | 1511010 |
| 24 3/4" | 32" | 1" | Male O-Ring | Male O-Ring | 1511011 |
| 29" | 19 3/4" | 1" | Male O-Ring | Male O-Ring | 1511012 |
| 21" | 18" | 1" | N/A | N/A | 1511013 |
| 29" | 20" | 1" | Male O-Ring | Male O-Ring | 1511014 |
| 29 3/4" | 32 1/8" | 1" | Male O-Ring | Male O-Ring | 1511015 |
| 27 1/2" | 10" | N/A | N/A | N/A | 1512002 |
| 34" | 20" | 1" | N/A | N/A | 1512003 |
| 24 1/2" | 15" | 1 3/8" | Male O-Ring | Male O-Ring | 1512004 |
| 24 1/2" | 15" | 3/4" | Male O-Ring | Male O-Ring | 1512006 |
| 29 1/4" | 20" | 1" | Male O-Ring | Male O-Ring | 1512007 |
| N/A | N/A | N/A | N/A | N/A | 1513001 |
| N/A | N/A | N/A | N/A | N/A | 1513002 |
| 26" | 27" | 3/4" | No. 8 (3/4"-16) Male O-Ring | No. 6 (5/8"-18) Male O-Ring | 1513004 |
| N/A | N/A | N/A | N/A | N/A | 1513005 |
| 30 1/2" | 27" | 29/32" | No. 8 (3/4"-16) Male O-Ring | No. 6 (5/8"-18) Male O-Ring | 1513007 |
| 27 1/2" | 24" | 1" | N/A | N/A | 1513008 |
| 28" | 25" | N/A | N/A | N/A | 1513010 |
| 29" | 24" | 1" | No. 8 (3/4"-16) Male O-Ring | No. 6 (5/8"-18) Male O-Ring | 1513011 |
| 28 1/2" | 26" | 1 1/2" | No. 8 (3/4"-16) Male O-Ring | No. 6 (5/8"-18) Male O-Ring | 1513012 |
| 27 1/4" | 22" | 1 1/2" | No. 8 (3/4"-16) Male O-Ring | No. 6 (5/8"-18) Male O-Ring | 1513013 |
| N/A | N/A | N/A | N/A | N/A | 1513014 |
| 31 3/8" | 24" | 7/8" | Male O-Ring | Male O-Ring | 1513017 |
| 28 3/4" | 16" | N/A | N/A | N/A | 1513018 |
| 36" | 22 1/2" | 3/4" | No. 8 (3/4"-16) Male O-Ring | No. 6 (5/8"-18) Male O-Ring | 1513019 |
| 29" | 26" | 3/4" | No. 8 (3/4"-16) Male O-Ring | No. 6 (5/8"-18) Male O-Ring | 1513020 |
| N/A | 16" | 1 1/4" | No. 8 (3/4"-16) Male O-Ring | No. 6 (5/8"-18) Male O-Ring | 1513021 |
| 36" | 22 1/2" | 1" | No. 8 (3/4"-16) Male O-Ring | No. 6 (5/8"-18) Male O-Ring | 1513022 |

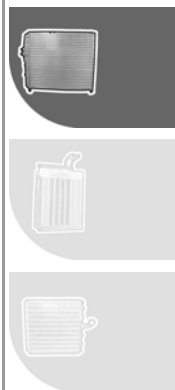

Condenser Specifications

Condenser Coil Specifications (continued)

| Length (A) | Width (B) | Thickness | Inlet | Outlet | Part No. |
|------------|-----------|-----------|-----------------------------|-----------------------------|----------|
| 29" | 27 3/4" | 1" | No. 8 (3/4"-16) Male O-Ring | No. 6 (5/8"-18) Male O-Ring | 1513024 |
| 27" | 28" | 3/4" | No. 8 (3/4"-16) Male O-Ring | No. 6 (5/8"-18) Male O-Ring | 1513025 |
| 27" | 23" | 1" | Male O-Ring | Male O-Ring | 1513026 |
| 21 53/64" | 19 37/64" | 53/64" | PAD mount | PAD mount | 1513027 |
| 21 23/64" | 24 25/64" | 5/8" | PAD mount | PAD mount | 1513028 |
| 34 19/64" | 33 3/8" | 13/16" | No. 8 (3/4"-16) Male O-Ring | No. 6 (5/8"-18) Male O-Ring | 1514002 |
| 34 5/16" | 33 3/8" | 3/4" | No. 8 (3/4"-16) Male O-Ring | No. 6 (5/8"-18) Male O-Ring | 1514003 |
| 33 17/32" | 27 7/8" | 15/16" | No. 8 (3/4"-16) Male O-Ring | No. 6 (5/8"-18) Male O-Ring | 1514005 |
| 41 13/16" | 29" | 27/32" | No. 8 (3/4"-16) Male O-Ring | No. 6 (5/8"-18) Male O-Ring | 1514006 |
| 30 21/32" | 8 15/32" | 1 1/4" | No. 8 (3/4"-16) Male O-Ring | No. 6 (5/8"-18) Male O-Ring | 1514007 |
| 33 5/8" | 35 13/16" | 51/64" | No. 8 (3/4"-16) Male O-Ring | No. 6 (5/8"-18) Male O-Ring | 1514008 |
| 36 11/32" | 42 1/8" | 51/64" | No. 8 (3/4"-16) Male O-Ring | No. 6 (5/8"-18) Male O-Ring | 1514011 |
| 36 11/32" | 42 1/8" | 51/64" | No. 8 (3/4"-16) Male O-Ring | No. 6 (5/8"-18) Male O-Ring | 1514012 |
| 41 13/16" | 29" | 59/64" | No. 8 (3/4"-16) Male O-Ring | No. 6 (5/8"-18) Male O-Ring | 1514013 |
| 29 5/8" | 10 5/16" | 1 9/32" | No. 8 (3/4"-16) Male O-Ring | No. 6 (5/8"-18) Male O-Ring | 1514014 |
| 32 1/12" | 20 11/16" | 45/64" | No. 8 (3/4"-16) Male O-Ring | No. 6 (5/8"-18) Male O-Ring | 1514015 |
| 32 9/32" | 17 41/64" | 1 1/4" | No. 8 (3/4"-16) Male O-Ring | No. 6 (5/8"-18) Male O-Ring | 1514016 |
| 32 1/12" | 20 11/16" | 45/64" | No. 8 (3/4"-16) Male O-Ring | No. 6 (5/8"-18) Male O-Ring | 1514017 |
| 43 7/32" | 36" | 3/4" | No. 8 (3/4"-16) Male O-Ring | No. 6 (5/8"-18) Male O-Ring | 1514018 |
| 43 1/2" | 38 3/32" | 27/32" | No. 8 (3/4"-16) Male O-Ring | No. 6 (5/8"-18) Male O-Ring | 1514019 |
| 39 3/4" | 36 21/32" | 53/64" | No. 8 (3/4"-16) Male O-Ring | No. 6 (5/8"-18) Male O-Ring | 1514020 |
| 43 15/32" | 38 3/32" | 27/32" | No. 8 (3/4"-16) Male O-Ring | No. 6 (5/8"-18) Male O-Ring | 1514021 |
| 31" | 23 3/4" | 3/4" | Block Fittings | Block Fittings | 1514022 |
| 6 1/2" | 39 1/2" | 1" | N/A | N/A | 1515002 |
| 24" | 25" | 1" | Male O-Ring | Male O-Ring | 1515003 |
| 28" | 23" | 1" | Male O-Ring | Male O-Ring | 1515004 |
| 32" | 8" | 1" | Male O-Ring | Male O-Ring | 1515008 |
| 24 1/2" | 9" | 2 5/8" | Male O-Ring | Male O-Ring | 1515009 |
| 28 1/4" | 8" | 1 3/8" | Male O-Ring | Male O-Ring | 1515010 |
| 48" | 33" | 3/4" | Male O-Ring | Male O-Ring | 1515011 |
| 31 1/2" | 8" | 1" | Male O-Ring | Male O-Ring | 1515012 |
| 39 7/8" | 32" | 3/4" | No. 8 (3/4"-16) Male O-Ring | No. 6 (5/8"-18) Male O-Ring | 1517001 |
| 25" | 12 1/4" | 1 3/4" | No. 8 (3/4"-16) Male O-Ring | No. 6 (5/8"-18) Male O-Ring | 1517003 |
| 18" | 27 3/16" | 2 1/4" | N/A | N/A | 1517004 |
| 31 5/8" | 8 19/32" | 13/16" | No. 8 (3/4"-16) Male O-Ring | No. 6 (5/8"-18) Male O-Ring | 1517007 |
| 32 45/64" | 8 7/16" | 1 1/8" | No. 8 (3/4"-16) Male O-Ring | No. 6 (5/8"-18) Male O-Ring | 1517008 |
| 29 3/8" | 10 5/16" | 1 1/8" | No. 8 (3/4"-16) Male O-Ring | No. 6 (5/8"-18) Male O-Ring | 1517009 |
| 31" | 33 5/32" | 1 1/4" | No. 8 (3/4"-16) Male O-Ring | No. 6 (5/8"-18) Male O-Ring | 1517011 |
| N/A | N/A | N/A | N/A | N/A | 1517012 |
| 27 1/4" | 14 3/4" | 3/4" | No. 8 (3/4"-16) Male O-Ring | No. 6 (5/8"-18) Male O-Ring | 1518001 |
| 29" | 15" | 7/8" | N/A | N/A | 1518005 |
| 36" | 15" | 7/8" | N/A | N/A | 1518006 |
| 33" | 9" | 1 3/4" | No. 8 (3/4"-16) Male O-Ring | No. 6 (5/8"-18) Male O-Ring | 1518007 |
| 26 1/4" | 14 1/2" | 1" | N/A | N/A | 1518008 |
| 26 1/4" | 15" | 1 3/8" | N/A | N/A | 1518009 |
| 37" | 16 1/4" | 7/8" | No. 8 (3/4"-16) Male O-Ring | No. 6 (5/8"-18) Male O-Ring | 1518010 |
| N/A | N/A | N/A | N/A | N/A | 1518011 |
| 29" | 15" | 3/4" | Male O-Ring | Male O-Ring | 1518014 |
| 29" | 15" | 3/4" | Male O-Ring | Male O-Ring | 1518015 |
| 38" | 8" | 1 3/8" | Male O-Ring | Male O-Ring | 1518016 |
| 33 1/2" | 9" | 1" | Male O-Ring | Male O-Ring | 1518017 |

CONDENSERS



Condenser Coil Specifications (continued)

| Length (A) | Width (B) | Thickness | Inlet | Outlet | Part No. |
|------------|-----------|-----------|-----------------------------|-----------------------------|----------|
| 23 51/64" | 14 45/64" | 3/4" | No. 8 (3/4"-16) Male O-Ring | No. 6 (5/8"-18) Male O-Ring | 1575001 |
| 29 51/64" | 13 19/32" | 3/4" | N/A | N/A | 1575002 |
| 35 51/64" | 11 1/2" | 3/4" | N/A | N/A | 1575003 |
| 29 41/64" | 10" | 3" | No. 8 (3/4"-16) Male O-Ring | No. 6 (5/8"-18) Male O-Ring | 1575004 |
| 20" | 18 3/32" | 1 3/32" | N/A | N/A | 1575005 |
| 32 51/64" | 9 13/32" | 2" | N/A | N/A | 1575006 |
| 23 1/2" | 12" | 1 1/2" | No. 8 (3/4"-16) Male O-Ring | No. 6 (5/8"-18) Male O-Ring | 1575007 |
| 23 51/64" | 9" | 2 5/8" | No. 8 (3/4"-16) Male O-Ring | No. 6 (5/8"-18) Male O-Ring | 1575008 |
| 23 15/16" | 8 1/8" | 1 7/8" | No. 8 (3/4"-16) Male O-Ring | No. 6 (5/8"-18) Male O-Ring | 1575009 |
| 45" | 10" | 6 31/64" | No. 8 (3/4"-16) Male O-Ring | No. 6 (5/8"-18) Male O-Ring | 1575010 |
| 29 1/2" | 20 1/3" | 2 1/4" | No. 8 (3/4"-16) Male O-Ring | No. 6 (5/8"-18) Male O-Ring | 1575013 |
| 40 61/64" | 26 5/8" | 2 1/4" | N/A | N/A | 1575014 |
| 20" | 14" | 1 47/64" | No. 8 (3/4"-16) Male O-Ring | No. 6 (5/8"-18) Male O-Ring | 1575017 |
| 32 1/4" | 16 7/8" | 1" | N/A | N/A | 1599001 |
| 27 1/4" | 14 3/4" | 3/4" | No. 8 (3/4"-16) Male O-Ring | No. 6 (5/8"-18) Male O-Ring | 1599002 |
| 24 7/16" | 14 1/8" | 1" | No. 8 (3/4"-16) Male O-Ring | No. 6 (5/8"-18) Male O-Ring | 1599003 |
| 36" | 20" | 2 1/4" | N/A | N/A | 1599004 |
| 29 3/4" | 15 3/4" | 3/4" | No. 8 (3/4"-16) Male O-Ring | No. 6 (5/8"-18) Male O-Ring | 1599005 |
| 23 15/16" | 6 1/2" | 2" | No. 8 (3/4"-16) Male O-Ring | No. 6 (5/8"-18) Male O-Ring | 1599006 |
| 28 51/64" | 28 45/64" | 1 3/32" | No. 8 (3/4"-16) Male O-Ring | No. 6 (5/8"-18) Male O-Ring | 1599007 |
| 32 11/16" | 17 7/8" | 1 3/8" | No. 10 Hose Barbed | 11/16" Male Inverted Thread | 1599008 |
| 29 51/64" | 19 51/64" | 27/32" | 1/2" Male O-Ring | 3/8" Male O-Ring | 1599009 |
| 30 1/4" | 9" | 2 19/32" | No. 8 (3/4"-16) Male O-Ring | No. 6 (5/8"-18) Male O-Ring | 1599010 |
| 27" | 20" | 1 1/2" | Male O-Ring | Male O-Ring | 1599011 |

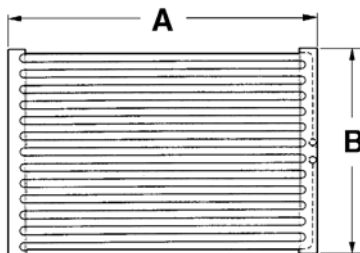

Universal Condenser Coil Options

| Length (A) | Width (B) | Thickness | Inlet | Outlet | Part No. |
|------------|-----------|-----------|-----------------------------|-----------------------------|----------|
| 27" | 14 3/4" | .89" | No. 8 (3/4"-16) Male O-Ring | No. 6 (5/8"-18) Male O-Ring | 1518001 |
| 23.8" | 15.7" | | No. 8 (3/4"-16) Male O-Ring | No. 6 (5/8"-18) Male O-Ring | 1575001 |
| 29.8" | 13.6" | 3/4" | No. 8 (3/4"-16) Male O-Ring | No. 6 (5/8"-18) Male O-Ring | 1575002 |
| 35.8" | 11.5" | | No. 8 (3/4"-16) Male O-Ring | No. 6 (5/8"-18) Male O-Ring | 1575003 |
| 20" | 18.1" | 1.09" | No. 8 (3/4"-16) Male O-Ring | No. 6 (5/8"-18) Male O-Ring | 1575005 |
| 32.8" | 9.4" | 2" | No. 8 (3/4"-16) Male O-Ring | No. 6 (5/8"-18) Male O-Ring | 1575011 |
| 29.8" | 15.2" | 3/4" | No. 8 (3/4"-16) Male O-Ring | No. 6 (5/8"-18) Male O-Ring | 1599005 |



Multi-Flow Condensers

Multi-Flow Condensers

The Multi-Flow design was created to make a very efficient condensing unit in a compact yet sturdy package. The first all-aluminum multi-flow condenser provides quality and innovation that marked the initial launch of this remarkable product. All the multi-flow condensers are USA made with all the skill and quality of American labor and materials under exacting quality and performance standards.

- **22mm design** - Gives you 33% more capacity when compared to traditional 16mm condenser of the same length and width
- **Thin Cross Tube Profile** - Decrease air resistance for improved engine cooling
- **Louvered Fins** - designed to provide heat transfer due to improved airflow
- **Patented End Tanks** - manufactured from a specially designed one-piece extrusion for extra strength and durability
- **Zinc Coating** - on the fins and cross flow tubes to improve corrosion resistance and maintain superior heat exchange capability
- **Nocolok Oven Brazing** - Patented process in which all aluminum parts are oven brazed to create homogenous assembly with joints that are leak free and reliable
- **Unitized construction** - A special fin support plate at the top and bottom bolsters structural integrity
- **Pre-punched side mounting flanges** - for mounting ease and flexibility

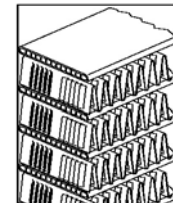

Flexible and Rugged

The compact design, high-heat transfer capability and side mounting flanges combine to make a very versatile unit to fit a wide variety of applications. Since one unit can fit a variety of vehicles, your inventory investment can go way down and still maintain more than adequate coverage. The performance of this condenser also offers advantages in terms of cooling capability over an equivalent size drop-in replacement given the same operating conditions. The robust construction ensures that the unit will stay on the vehicle for years in good operating condition with no "come-backs" to worry about.

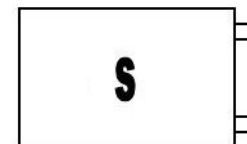
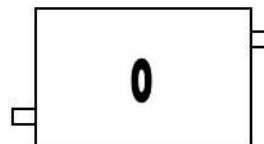
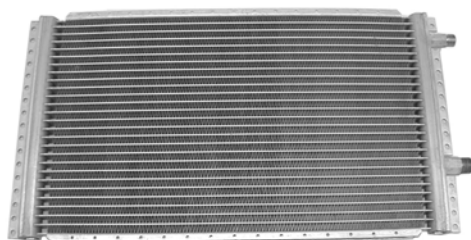

Multi-Flow Condenser Coil Specifications

| Length (A) | Width (B) | Thickness | Inlet | Outlet | Configuration | Part No. |
|------------|-----------|-----------|--------------------|--------------------|---------------|----------|
| 25 3/4" | 10 23/32" | 55/64" | 3/4-16 Male O-Ring | 5/8-18 Male O-Ring | S | 1599012 |
| 21 3/4" | 11 31/32" | 55/64" | 3/4-16 Male O-Ring | 5/8-18 Male O-Ring | S | 1599013 |
| 21 3/4" | 13 31/32" | 55/64" | 3/4-16 Male O-Ring | 5/8-18 Male O-Ring | S | 1599014 |
| 29 19/32" | 15 17/32" | 55/64" | 3/4-16 Male O-Ring | 5/8-18 Male O-Ring | S | 1599015 |
| 29 19/32" | 19 35/64" | 55/64" | 3/4-16 Male O-Ring | 5/8-18 Male O-Ring | S | 1599016 |
| 25 3/4" | 12" | 55/64" | 3/4-16 Male O-Ring | 5/8-18 Male O-Ring | S | 1599101 |
| 25 3/4" | 13 31/32" | 55/64" | 3/4-16 Male O-Ring | 5/8-18 Male O-Ring | S | 1599102 |

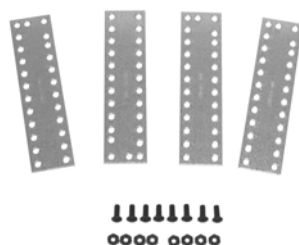

Multi-Flow Condenser Brackets

| Description | Part No. |
|---|----------|
| UNIVERSAL BRACKET FOR MULTI-FLOW CONDENSERS | 3499019 |

CONDENSERS



Mounting Hardware

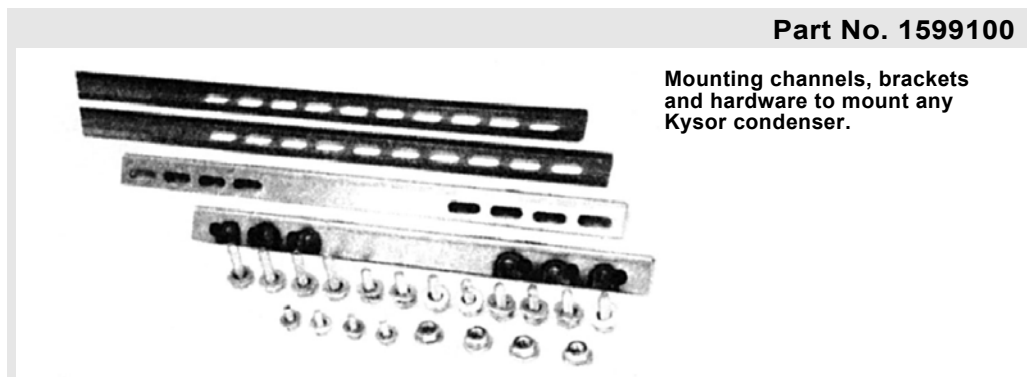

Part No. 1599100

Mounting channels, brackets and hardware to mount any Kysor condenser.

Typical Header Types

| Type 1 | Type 2 | Type 3 | Type 4 |
|--|---|--|--|
| <p>SERPENTINE</p> <p>Continuous extruded aluminum tube, 3/4 to 2 inches thick. The fin is either Skyve type or vacuum brazed ribbon type spaced approximately 14 fins per inch. High heat rejection, compact size exact OEM replacements.</p> | <p>TUBE AND FIN</p> <p>Constructed with .008 thick aluminum corrugated fin 3/4 to 1 1/2 inches thick. Fin spacing at 10 to 12 fins per inch providing maximum heat rejection. Tubes are either copper or aluminum.</p> | <p>GRILLDENSER</p> <p>Constructed with .030 to .050 thick aluminum, fins are 3/4 inch thick. Fins are spaced at 2 to 4 fins per inch providing minimal air flow restriction. Tubes are either .035 inches wall aluminum or .022 inches wall copper.</p> | <p>PARALLEL FLOW</p> <p>Constructed with tube assemblies connecting to a common tank at both ends of the condenser. Commonly found in smaller, newer R-134a vehicles with limited air flow. Offers superior heat rejection.</p> |

Service Tips

The condenser and evaporator are both designed to exchange heat. Heat is removed from the Cab by the evaporator and released outside the Cab by the condenser.

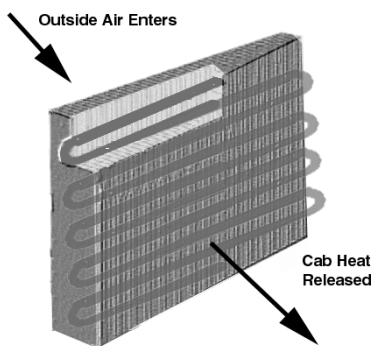

Condenser

Condenser Coil Service Tips

| | |
|---|--|
| Condenser Location | The condenser is located on the high-pressure side of the system, while the evaporator is located on the low-pressure side. |
| Coil Fins | Make sure the coil fins are clean and free of debris and obstructions. |
| Inspect for Damage | Inspect for abrasions or damaged tubing. Straighten bent fins with fin comb. |
| Operating Temperature | With the system running the evaporator will be cold to touch while the condenser will be hot to touch. |
| Ensure Operability | Ensure the condenser fan is operable. |
| Temperature Change — Inlet to Outlet | The condenser will produce (5° - 15°C) temperature decreases from inlet to outlet, while the evaporator will return slight temperature increases from inlet to outlet. |

Condenser Fan Assemblies

Part No. 1015004



Speed: **N/A** | A: **9"**
 Voltage: **12** | B: **9 11/16"**
 Rotation: **CW** | C: **5 15/32"**
 Vent: **N/A** | D: **8 7/64"**
 | E: **2 19/64"**

Part No. 1015008



Speed: **N/A** | A: **10"**
 Voltage: **12** | B: **10 7/32"**
 Rotation: **N/A** | C: **10 21/32"**
 Vent: **N/A** | D: **5 1/8"**
 | E: **2 1/2"**

Part No. 1075021



Speed: **N/A** | A: **16"**
 Voltage: **12** | B: **16 3/4"**
 Rotation: **CCW** | C: **16 27/64"**
 Mount: **N/A** | D: **8 7/64"**
 Vent: **N/A** | E: **3 13/16"**

Part No. 1075022



Speed: **N/A** | A: **9"**
 Voltage: **12** | B: **9 11/16"**
 Rotation: **CW** | C: **5 15/32"**
 Mount: **N/A** | D: **8 7/64"**
 Vent: **N/A** | E: **2 19/64"**

Part No. 1099082

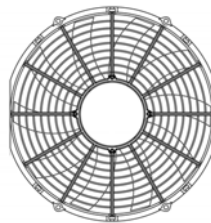

Speed: **N/A** | A: **12 37/64"**
 Voltage: **N/A** | B: **13 7/32"**
 Rotation: **CCW** | C: **6 41/64"**
 Mount: **N/A** | D: **11 1/2"**
 Vent: **N/A** | E: **1 13/16"**

Part No. 4399002

Universal Condenser Fan Bracket

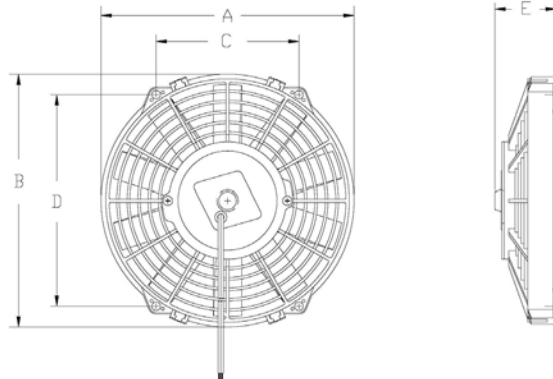
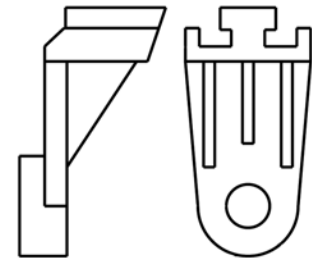

Condenser Fan Specifications

| Speed | Voltage | Rotation | Mount | A | B | C | D | Dia. | Vent | Part No. |
|-------|---------|----------|--------------------|-----------|----------|-----------|---------|----------|------|----------------|
| N/A | 12 | CW | W/Shrd & Fan | 9" | 9 11/16" | 5 15/32" | 8 7/64" | 2 19/64" | N/A | 1015004 |
| N/A | 12 | N/A | Condenser Fan Assy | 10" | 10 7/32" | 10 21/32" | 5 1/8" | 2 1/2" | N/A | 1015008 |
| N/A | 12 | CCW | Condenser Fan Assy | 16" | 16 3/4" | 16 27/64" | 8 7/64" | 3 13/16" | N/A | 1075021 |
| N/A | 12 | CW | Condenser Fan Assy | 9" | 9 11/16" | 5 15/32" | 8 7/64" | 2 19/64" | N/A | 1075022 |
| N/A | N/A | CCW | Condenser Fan Assy | 12 37/64" | 13 7/32" | 6 41/64" | 11 1/2" | 1 13/16" | N/A | 1099082 |

CONDENSERS

